



EN / D / DK



ELKA
PROTECTION AGAINST EXTREMES

WATERPROOF PROFESSIONAL WORKWEAR

ELKA Rainwear creates durable, waterproof workwear that protects against nature's extremes and wet working environments. Here, you will definitely find the workwear that suits your profession and your needs – in high quality and well-thought-out design. ELKA is among Europe's leading manufacturers of waterproof workwear, exporting to more than 40 countries.

At ELKA, we are dedicated to creating high-quality workwear with the longest possible lifespan. When we develop products, we focus on durability, comfort, and functionality, and you will feel this as optimal protection – against rain, snow and cold when working outdoors and against water in wet working environments.

RESPONSIBLE STEPS

We are reducing the number of pages in our main catalogue compared to previous catalogues. We do this to save on paper, to reduce printing resources, and to initiate a gradual shift where our printed format should be seen more as a place for selected product information rather than the entire story.

The complete overview is available online at www.elkarainwear.dk.

The desire to achieve a catalogue with fewer pages means that some products will be displayed in less space than in previous catalogues. In such cases, the entire product information is available on our website, while in the catalogue, the most important product information is presented through text and symbols. Therefore, remember to join us online.

Furthermore, this catalogue is printed in Denmark, near our head office, on paper that is FSC®-certified and certified by The Nordic Swan Ecolabel.

ELKA PRODUCT INFORMATION

Our stock items are available in sizes ranging from S to 3XL. Many styles are also available in XS, 4XL, and 5XL.

You can find the prices in our corresponding price list or on our B2B webshop. Please note that 4XL and 5XL sizes have a surcharge of 25%. Similarly, workwear trousers in sizes 64, 66, and 68 also have a surcharge of 25%.

The displayed colors and product images for each item are ELKA stock items. However, on selected Made in Europe PU and PVC products, we show both the colors that are in stock and the colors that are available as special orders upon further agreement.





ELKA

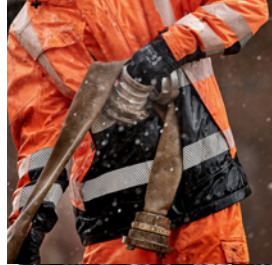

**VISIBLE
XTREME**

9



**WORKING
XTREME**

27



**SECURETECH
MULTINORM**

51



DRY ZONE

63



**MADE IN
EUROPE
PU**

75



**MADE IN
EUROPE
PVC**

86

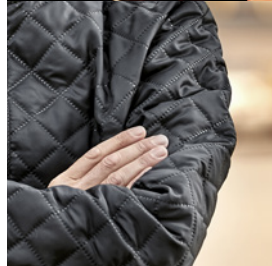

**MADE IN
EUROPE
THERMAL**

96



**ELKA
ELEMENTS**

105



NEW

At ELKA, we are dedicated to creating functional and durable high-quality workwear. Now, we're taking it a step further by incorporating recycled materials as part of our commitment to the future. We proudly introduce:

RECYCLED by ELKA

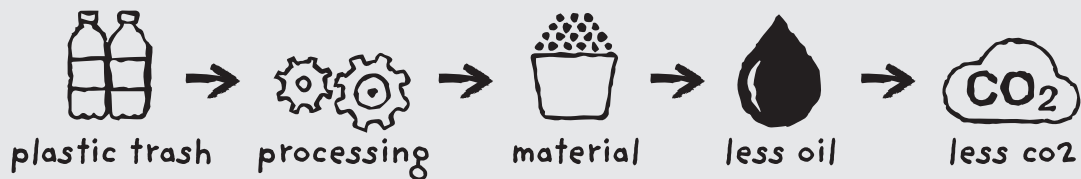

“Recycled by ELKA” is our new collection of products, primarily crafted using recycled materials. The polyester fabric in these garments is recycled polyester, a type of fiber made from recycled sources, including PET bottles. By utilizing recycled polyester, we reduce oil consumption and CO₂ emissions during production compared to using entirely virgin materials.

The recycled polyester used in “Recycled by ELKA” products is certified, ensuring fabric traceability.

For an overview of our new recycled collection, please refer to the following page.

- // Recycled polyester.
- // OEKO-TEX® STANDARD 100 certified.
- // Waterproof or water repellent properties.
- // Breathable – stay dry, also on the inside.
- // Stretch – for optimal freedom of movement.
- // PFC-free treatment.
- // All main zippers manufactured by YKK.
- // Black LOXY® reflective tape.
- // Stretch Cordura® reinforcements.
- // Durability, tear resistance, functionality, etc. tested in relevant work environments.

THE NEW COLLECTION

RECYCLED by ELKA

IS OEKO-TEX® STANDARD 100 CERTIFIED



OEKO-TEX® STANDARD 100 is one of the world's best-known labels for textiles tested for harmful substances. When a textile article carries the STANDARD 100 label, you can be certain that every component of this article, i.e. every thread, button and other accessories, has been tested for harmful substances and that the article therefore is harmless for human health.

The test is conducted by independent OEKO-TEX® partner institutes on the basis of extensive OEKO-TEX® criteria catalog. In the test they take into account numerous regulated and non-regulated substances, which may be harmful to human health. In many cases the limit values for the STANDARD 100 go beyond national and international requirements. The criteria catalog is updated at least once a year and expanded with new scientific knowledge or statutory requirements.

TRANSPARENCY – A CORE VALUE AT ELKA

At ELKA, we want to keep our promises. We have been asked if we can provide the number of PET bottles used in the manufacture of each product. We've chosen not to provide specific bottle counts, as it's important to note that recycled polyester isn't solely derived from PET bottles. Other recycled materials are incorporated, making the quantification of bottles complex. Nonetheless, transparency remains a cornerstone of ELKA's values. Therefore, we detail the composition of recycled and virgin components for each product in this overview.

ART. 182403R



VISIBLE XTREME RECYCLED WAIST TROUSERS

Component	Description	% recycled
Main fabric	100% recycled polyester twill (30% PU membrane)	70%
Reinforcement	100% polyamide Taslon jacquard with PU membrane	0%
Reinforcement	Stretch Cordura	0%
Reflex		0%
Main zipper	YKK	0%
Labels	All woven labels	100%
All other Trims		0%

See product on page 11.

ART. 282404R

ART. 282404SR



VISIBLE XTREME RECYCLED WAIST TROUSERS

Component	Description	% recycled
Main fabric	100% recycled polyester (8% elastane)	92%
Reinforcement	100% polyamide Taslon jacquard with PU membrane	0%
Reinforcement	Stretch Cordura	0%
Reflex		0%
Main zipper	YKK	0%
Labels	All woven labels	100%
All other Trims		0%

See product on page 13.

ART. 182403



WORKING XTREME RECYCLED WAIST TROUSERS

Component	Description	% recycled
Main fabric	100% recycled polyester twill (30% PU membrane)	70%
Reinforcement	100% polyamide Taslon jacquard with PU membrane	0%
Reinforcement	Stretch Cordura	0%
Reflex	Black LOXY 3,0 cm	0%
Main zipper	YKK	0%
Labels	All woven labels	100%
All other Trims		0%

See product on page 29.

ART. 282404

ART. 282404S



WORKING XTREME RECYCLED WAIST TROUSERS

Component	Description	% recycled
Main fabric	100% recycled polyamide ripstop (10% elastane)	90%
Reinforcement	Stretch Cordura	0%
Main zipper	YKK	0%
Labels	All woven labels	100%
All other Trims		0%

See product on page 33.

ART. 186003R



VISIBLE XTREME RECYCLED JACKET

Component	Description	% recycled
Main fabric	100% recycled polyester twill (30% PU membrane)	70%
Reinforcement	100% polyamide Taslon jacquard with PU membrane	0%
Lining - 1	100% recycled polyester Pongee	100%
Lining - 2	100% recycled polyester mesh	100%
Reflex		0%
Main zipper	YKK	0%
Labels	All woven labels	100%
All other trims		0%

See product on page 10.

ART. 116503R



VISIBLE XTREME RECYCLED SOFTSHELL JACKET

Component	Description	% recycled
Main fabric	100% recycled polyester twill (10% PU membrane)	90%
Lining	100% recycled polyester Pongee	100%
Reflex		0%
Main zipper	YKK	0%
Labels	All woven labels	100%
All other Trims		0%

See product on page 12.

ART. 186003



WORKING XTREME RECYCLED JACKET

Component	Description	% recycled
Main fabric	100% recycled polyester twill (30% PU membrane)	70%
Reinforcement	100% polyamide Taslon jacquard with PU membrane	0%
Lining - 1	100% recycled polyester Pongee	100%
Lining - 2	100% recycled polyester mesh	100%
Reflex	Black LOXY 1,5 cm	0%
Main zipper	YKK	0%
Labels	All woven labels	100%
All other trims		0%

See product on page 28.

ART. 116503



WORKING XTREME RECYCLED SOFTSHELL JACKET

Component	Description	% recycled
Main fabric	100% recycled polyester twill (10% TPU membrane)	90%
Lining	100% recycled polyester Pongee	100%
Reflex	Black LOXY 1,5 cm	0%
Main zipper	YKK	0%
Labels	All woven labels	100%
All other Trims		0%

See product on page 30.

ART. 106003



WORKING XTREME HYBRID JACKET

Component	Description	% recycled
Main fabric A	100% recycled polyester twill (10% TPU membrane)	90%
Main fabric B	100% polyamide ripstop	0%
Padding	comfortemp® recycled polyester	100%
Main zipper	YKK	0%
Labels	All woven labels	100%
All other Trims		0%

See product on page 31.



RESPONSIBILITY FROM THE ELKA PERSPECTIVE

At ELKA, we continuously prioritize responsibility in the development and manufacturing of functional, high-quality workwear. It is particularly important for ELKA to ensure that our products remain in use for as long as possible, and we strive to achieve this in several ways.

We collaborate with customers and end-users to create functional clothing, ensuring a high demand for the products we develop.

During the product development phase, we prioritize selecting high-quality raw materials to provide the best possible foundation for a long product lifespan.

We also incorporate elements into the design that allow the product to serve multiple purposes. This means that we emphasize designing our products, for example, with zip-in/zip-out functionality or detachable sleeves to easily adapt to different needs in changing weather conditions.

Concerning aesthetic design, we draw inspiration from Nordic minimalism and deliberately avoid incorporating period-typical elements that could shorten the product's lifespan due to changing fashion trends.

All of these efforts contribute to extending the lifespan of our products, making them as durable as possible.

On these pages, we offer insights into the perspectives included in ELKA's responsibility strategy.

WE KEEP A CLOSE EYE ON THE CHEMICALS

ELKA's production of workwear is based on a chemical strategy. This strategy has been developed in close collaboration with Bureau Veritas in Denmark, a leading company in terms of quality, environment, work environment, safety and social responsibility. As part of this collaboration, a testing program is included, where we regularly test the content of chemicals in selected products. For testing, ELKA always use a third-party laboratory, and often, the tests will be carried out by a Bureau Veritas laboratory.





WE COMPLY WITH REACH

All ELKA's products are produced in accordance with REACH. REACH is the EU's basic chemical legislation, and the term stands for "Registration, Evaluation, Authorization and Restriction of Chemicals". The REACH regulation is, among other things, adopted to improve the protection of human health and the environment against the risks chemicals may cause.



BSCI OR SEDEX CERTIFIED PARTNERS

We focus on ensuring responsibility, also in our supply chain. Therefore, all our suppliers from the East are either BSCI (The Business Social Compliance Initiative) or Sedex (Supplier Ethical Data Exchange) certified. Both are global organizations that focus on helping companies be ethically and socially responsible.



EUROPEAN CERTIFICATIONS

The majority of the ELKA range meets the requirement for PPE personal protective equipment, approved by accredited test institutes. The norms for each standard are tested on the product, to pass the EU-set standards for safety and performance.



OEKO-TEX® STANDARD 100

Selected products in the ELKA range are certified according to OEKO-TEX® STANDARD 100. This standard is one of the world's best-known labels for textiles tested for harmful substances.



EUROPEAN PRODUCTION

We are pleased to offer production at our own factory in Europe, geographically close to our head office in Denmark. In total, approx. 50% of our garments are made in Europe, with fabrics and trim of European origin.



RECYCLED BY ELKA

We have initiated a process where we incorporate the use of recycled materials in the manufacturing of our workwear. See page 4-5.

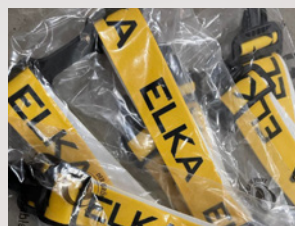

WE TRY TO REDUCE WASTE

We are focused on minimizing waste, both in our products and at ELKA as a workplace.

In our products, for example, we have changed the practice regarding extra accessories. We no longer include extra buttons with our products, and we no longer provide glue for repairs in our waders products – because we want save the environment for a lot of waste. If our customers require these items in specific cases, we are happy to assist.

Similarly, we have changed the way we package our braces for overalls. Previously, they were in a separate plastic bag, now they are folded inside the product as we aim to reduce the use of plastic bags.

At ELKA as a workplace, we have also implemented new initiatives and changed routines. Heat pumps have replaced oil furnace, lighting has been switched to LED, cardboard and plastic are sent for recycling, and we minimize paper and printing by using multiple screens. Additionally, we have installed solar panels at our factory in Lithuania.



Visible Xtreme

BY ELKA

EN

The EN ISO 20471 certified **Visible Xtreme** series are high quality technical products, crafted for professionals. It will make you highly visible with the latest European safety standards and with the wide garment assortment it is always possible to keep warm and be protected against blistering wind and persistent rain.

The Scandinavian designed waterproof workwear is functional and durable and compares to regular workwear you can use all day long.

D

Unsere EN ISO 20471 zertifizierte **Visible Xtreme** Serie besteht aus qualitativ sehr hochwertigen Komponenten, welche für den Profi konzipiert sind. Die Produkte bieten eine hohe Sichtbarkeit und sind alle gemäß neuesten europäischen Standards. Mit einer breiten Materialauswahl ist es immer möglich warmgehalten und gegen „Wind und Wetter“ geschützt zu sein.

Die Skandinavisch inspirierte Wetzerschutzbekleidung ist funktionell, strapazierbar und ist wie „normale“ Workwear, den ganzen Tag einsetzbar.

DK

Vores EN ISO 20471-certificerede **Visible Xtreme** produkter er en serie af teknisk arbejdstøj af høj kvalitet, udviklet til de professionelle erhverv. Produkterne sikrer høj synlighed og lever op til de nyeste europæiske sikkerhedsstandarder og med det brede sortiment er det altid muligt at beskytte dig mod stærk vind, vedvarende regn samt kulde.

Det vandtætte arbejdstøj er i et skandinavisk design, funktionelt og slidstærkt og kan sammenlignes med almindeligt arbejdstøj, som kan bruges dagen lang.

ART. 186003R

NEW



Visible Xtreme BY ELKA

WATER COLUMN 15.000 MM

<p>Size XS - 5XL Size L back length: 81 cm / 32 in Water column main fabric: > 15.000 mm H₂O Breathability: > 5.000 g/m²/24h</p>		
<p>EN 343 4 3 X</p>	<p>EN ISO 20471 2 XS-S</p>	<p>EN ISO 20471 3 M-5XL</p>
<p>RIS-3279-TOM</p>	<p>OEKO TEX® STANDARD 100 2376/375 DIT</p>	
<p>033 FL. ORANGE/ BLACK</p>	<p>042 FL. YELLOW/ BLACK</p>	
<p>100% RECYCLED POLYESTER. 75D TWILL. 190 G/M²</p>		

RECYCLED by ELKA



EN VISIBLE XTREME RECYCLED JACKET

- // Taped seams
- // YKK main zipper
- // Double storm flap with hook & loop
- // Chest pocket with coated zipper containing hidden ID pocket
- // Hidden multifunction pocket for Tablet or notebook (A4)
- // 2 pockets with zipper
- // Detachable hood with string and hook & loop adjustment
- // Reinforced on shoulders
- // Mesh lining for optimized breathability
- // Sewn incisions on sleeves for better fit
- // Sleeves with hook & loop adjustment, hand protection and internal wind catch with thumb hole
- // Adjustable lower hem
- // Print access
- // Segmented EN ISO 20471 certified reflective tape

D VISIBLE XTREME RECYCLET JACKE

- // Nähte getaped
- // YKK-Frontreißverschluss
- // Doppelte Wetterschutzleiste mit Klett
- // Brusttasche mit wasserdichtem Reißverschluss und mit Versteckte Ausweis-Tasche
- // Versteckte Innentasche für Tablet/A4-Block
- // 2 Taschen mit Reißverschluss
- // Abnehmbare Kapuze mit Kordel und Klettverstellung
- // Schulterverstärkung
- // Netzfutter für verbesserte Atmungsaktivität
- // Angepasster Schnitt an den Ärmeln für einen besseren Passform
- // Verstellbar Ärmel mit Klettverschluss, Handschutz und Wetterschutzleiste innen mit Daumenloch
- // Verstellbar im Bund
- // Zugang für Veredelung
- // Segmentierte EN ISO 20471 Reflexstreifen

DK VISIBLE XTREME RECYCLED JAKKE

- // Tapede sømme
- // YKK-lynlås i front
- // Dobbelt vindfang med gribebånd
- // Brystlomme med coated lynlås, der indeholder ID-lomme
- // Skjult multifunktions lomme til tablet og notesbog (A4)
- // 2 lommer med lynlås
- // Justerbar aftagelig hætte med gribebånd på bagsiden
- // Forstærkning på skuldre
- // Mesh foer for optimeret åndbarhed
- // Indsnit på ærmer for bedre pasform
- // Justerbare ærmer med gribebånd, håndbeskyttelse og indvendig vindfang med tommelfingerhul
- // Justerbar nedre kant
- // Adgang til rygprint
- // Segmenterede EN ISO 20471 certificerede reflekser



Windproof
Waterproof
Breathable



Recycled
by ELKA



Stretch

ART. 182403R

NEW



Visible Xtreme BY ELKA

WATER COLUMN 15.000 MM

Size XS - 5XL

Size L inner leg length: 82 cm / 32 in
Water column main fabric: > 15.000 mm H₂O
Breathability: > 5.000 g/m²/24h



033

FL. ORANGE/ BLACK



042

FL. YELLOW/ BLACK

100% RECYCLED POLYESTER. 75D TWILL.
190 G/M²



RECYCLED by ELKA



EN VISIBLE XTREME RECYCLED WAIST TROUSERS

- // Taped seams
- // Adjustable waist with hook & loop
- // Vertical pockets with coated zippers
- // Side pocket with zipper and flap
- // Cordura® tool pocket
- // Cordura® reinforcement on knee pocket
- // Polyamide reinforcements on the back and leg opening
- // Legs with zipper
- // Adjustable legs with hook & loop
- // Segmented EN ISO 20471 certified reflective tape

D VISIBLE XTREME RECYCLED BUNDHOSE

- // Nähte getaped
- // Verstellbar m. Klett im Bund
- // Vertikale Taschen m. wasserdichten Reißverschlüssen und Patte
- // Seitentasche mit Reißverschluss und Patte
- // Cordura®-verstärkte Werkzeultasche
- // Cordura®-verstärkte Knietasche
- // Polyamidverstärkung an Gesäß und Beine
- // Reißverschluss am Bein
- // Verstellbar im Bein mit Klett
- // Segmentierte EN ISO 20471 Reflexstreifen

DK VISIBLE XTREME RECYCLED TALJEBUKSER

- // Tapede sømme
- // Justerbar talje med gribebånd
- // Vertikal lomme med coated lynlås
- // Sidelomme med lynlås og klap
- // Cordura® tommestok lomme
- // Cordura® forstærket knælomme
- // Polyamidforstærkning bagpå og i benene
- // Lynlås i ben
- // Justerbare ben med gribebånd
- // Segmenterede EN ISO 20471 certificerede reflekser



Windproof
Waterproof
Breathable



Recycled
by ELKA



Stretch



Zipper in
legs



Pockets for
knee pads

ART. 116503R

NEW



Visible Xtreme BY ELKA

WATER COLUMN 8.000 MM

Size XS - 5XL
Size L back length: 78 cm / 30.5 in
Water column main fabric: > 8.000 mm H₂O
Breathability: > 5.000 g/m²/24h

EN ISO 20471 2 XS-S EN ISO 20471 3 M-5XL RIS-3279-TOM

OEKO TEX® STANDARD 100 2376-375 DIT

033 FL. ORANGE/ BLACK **042** FL. YELLOW/ BLACK

100% RECYCLED POLYESTER. 75D TWILL. 245 G/M²

40 MAX. 25X [Washing symbols: no bleach, no iron, no dry clean, no tumble dry]

RECYCLED by ELKA



EN VISIBLE XTREME RECYCLED SOFTSHELL JACKET

- // Windproof, water repellent and breathable
- // Reversed YKK main zipper and internal storm flap
- // Detachable hood with string and hook & loop adjustment
- // Chest pocket with zipper and hidden ID pocket
- // 2 pockets with zipper
- // Sleeves with hook & loop adjustment, hand protection and internal wind catch with thumb hole
- // Adjustable lower hem
- // Extra length on back
- // Segmented reflective tape

D VISIBLE XTREME RECYCEL T SOFTSHELLJACKE

- // Winddicht, wasserabweisend und atmungsaktiv
- // Umgekehrter YKK-Frontreißverschluss und Wetterschutzleiste innen
- // Abnehmbare Kapuze mit Kordel und Klettverstellung
- // Brusttasche mit Reißverschluss und versteckter Ausweistasche
- // 2 Taschen mit Reißverschluss
- // Verstellbar Ärmel mit Klettverschluss, Handschutz und Wetterschutzleiste innen mit Daumenloch
- // Verstellbar im Bund
- // Extra Lang hinten
- // Segmentierte Reflexstreifen

DK VISIBLE XTREME RECYCLED SOFTSHELL JAKKE

- // Vindtæt, vandafvisende og åndbar
- // Reversed YKK-lynlås i front og indvendigt vindfang
- // Justerbar aftagelig hætte med gribebånd på bagsiden
- // Brystlomme med lynlås og skjult ID lomme i plast
- // 2 lommer med lynlås
- // Justerbare ærmer med gribebånd, håndbeskyttelse og indvendig vindfang med tommelfingerhul
- // Justerbar nedre kant
- // Ekstra ryglængde
- // Segmenterede reflekser



Recycled by ELKA

ART. 282404R

ART. 282404SR

NEW

POCKETS FOR KNEE PADS:
ART. 3260 KNEE PADS ARE
SUITABLE, SEE PAGE 111.

**Visible
Xtreme**
BY ELKA
ART. 282404R:

Size EU 44 - 68

Size UK 28.5 - 52.5

Inner leg length: 82 cm / 32 in

ART. 282404SR:

Size EU 23 - 31

Size UK 30.5 - 46.5

Inner leg length: 76 cm / 30 in

EN ISO 20471

23-27
44-54

EN ISO 20471

28-31
56-68

RIS-3279-TOM

28-31
56-68**033**FL. ORANGE/
BLACK**042**FL. YELLOW/
BLACK

92% RECYCLED POLYESTER.
8% ELASTANE. TWILL. 270 G/M²



MAX. 20X

**ART. 282404R TROUSERS CAN
EASILY BE LET DOWN TO EXTEND
THE LENGTH BY 4 CM / 1.5 IN.**

**SEE PAGE 32 FOR MORE INFO
ON THE NEW HYBRID ELKA
WORKWEAR.**

RECYCLED by ELKA

**EN VISIBLE XTREME RECYCLED
WAIST TROUSERS**

- // Water repellent
- // Vertical pockets with reversed zippers
- // Cordura® tool pocket
- // Cordura® reinforcement on knee pocket
- // Two back pockets in Cordura® reinforcements
- // 2 front pockets
- // Segmented EN ISO 20471 certified reflective tape
- // Leg length can be extended by 4 cm / 1.5 in (Art. 282404R)

**D VISIBLE XTREME RECYCLET
BUNDHOSE**

- // Wasserabweisend
- // Vertikale Taschen m. reversed Reißverschlüssen
- // Cordura®-verstärkte Werkzeugtasche
- // Cordura®-verstärkte Knietasche
- // 2 Gesäßtaschen aus Cordura®-Material
- // 2 Taschen
- // Segmentierte EN ISO 20471 Reflexstreifen
- // Die Beinlänge kann um 4 cm verlängert werden (Art. 282404R)

**DK VISIBLE XTREME RECYCLED
TALJEBUKSER**

- // Vandafisende
- // Vertikal lomme med reversed lynlås
- // Cordura® tommestok lomme
- // Cordura® forstærket knælomme
- // 2 baglommer i Cordura® forstærkning bagpå
- // 2 frontlommer
- // Segmenterede EN ISO 20471 certificerede reflekser
- // Benlængde kan forlænges med 4 cm (Art. 282404R)

Recycled
by ELKA

Stretch

Pockets for
knee pads

ART. 186100R

Visible
Xtreme
BY ELKAWATER COLUMN
20.000
MM

Size XS - 5XL

Size L back length: 81 cm / 32 in

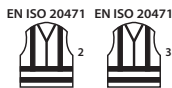
Water column main fabric: > 20.000 mm H₂O

033

FL. ORANGE/
BLACK

042

FL. YELLOW/
BLACK100% POLYESTER, 75D TWILL, 190 G/M²

**PREMIUM INSULATION MADE
FROM RECYCLED BOTTLES
- COMFORTEMP® FROM
FREUDENBERG.**

EN VISIBLE XTREME STRETCH WINTER JACKET

- // Taped seams
- // Lightweight winter jacket with high end insulation
- // The padding is comfortemp® from Freudenberg
- // 2-way YKK main zipper
- // Chest pocket with flap containing hidden ID pocket
- // Vertical chest pocket with coated zipper
- // Hidden multifunction pocket for Tablet or notebook (A4)
- // Double storm flap with hook & loop
- // 2 pockets with zipper and flaps
- // Detachable hood with string and hook & loop adjustment
- // Reinforced on shoulders
- // Sleeves with hook & loop adjustment and hand protection
- // Adjustable lower hem
- // Print access
- // Segmented EN ISO 20471 certified reflective tape

D VISIBLE XTREME WINTERJACKE MIT STRETCH

- // Nähte getaped
- // Leichtgewichts-Winterjacke mit hoher Isolierfähigkeit
- // Die Wattierung ist comfortemp® von der Fa. Freudenberg
- // 2-Wege YKK-Frontreißverschluss
- // Brusttasche mit Patte und mit Versteckte Ausweis-Tasche
- // Vertikale Brusttasche mit Wasserdichtem Reißverschluss
- // Versteckte Innentasche für Tablet/A4-Block
- // Doppelte Wetterschutzleiste mit Klett
- // 2 Taschen m. Reißverschluss
- // Abnehmbare Kapuze m. Kordel und Klettverstellung
- // Schulterverstärkung
- // Verstellbar Ärmel mit Klettverschluss und Handschutz
- // Verstellbar im Bund
- // Zugang für Veredelung
- // Segmentierte EN ISO 20471 Reflexstreifen

DK VISIBLE XTREME STRETCH VINTERJAKKE

- // Tapede sømme
- // Letvægtsvinterjakke med høj isoleringsevne
- // Vatteringen er comfortemp® fra Freudenberg
- // 2-vejs YKK-lynlås i front
- // Brystlomme med klap, der indeholder ID-lomme.
- // Vertikal brystlomme med coated lynlås
- // Skjult multifunktions lomme til tablet og notesbog (A4)
- // Dobbelt vindfang med gribebånd
- // 2 lommer med lynlås
- // Justerbar aftagelig hætte med gribebånd på bagsiden
- // Forstærkning på skuldre
- // Justerbare ærmer med gribebånd og med håndbeskyttelse
- // Justerbar nederste kant
- // Mulighed for rygprint
- // Segmenterede EN ISO 20471 certificerede reflekser



Stretch



Winter

ART. 18600R



Visible Xtreme
BY ELKA

WATER COLUMN
20.000
MM

Size XS - 5XL

Size L back length: 81 cm / 32 in
Water column main fabric: > 20.000 mm H₂O
Breathability: > 5.000 g/m²/24h



033

FL. ORANGE/
BLACK



042

FL. YELLOW/
BLACK

100% POLYESTER. 75D TWILL. 190 G/M²



READY FOR ZIP-IN JACKET
ART. 150015R / ART. 150014R /
ART. 150015 / ART. 150014 /
ART. 160014.

VISIBLE XTREME

EN VISIBLE XTREME STRETCH JACKET

- // Taped seams
- // YKK main zipper
- // Chest pocket with flap containing hidden ID pocket
- // Vertical chest pocket with coated zipper
- // Hidden multifunction pocket for tablet or notebook (A4)
- // Double storm flap with hook & loop
- // 2 pockets with zipper and flaps
- // Detachable hood with string and hook & loop adjustment
- // Reinforced on shoulders
- // Mesh lining for optimized breathability
- // Sewn incisions on sleeves for better fit
- // Sleeves with hook & loop adjustment
- // Adjustable lower hem
- // Print access
- // Segmented EN ISO 20471 certified reflective tape

D VISIBLE XTREME STRETCH-JACKE

- // Nähte getaped
- // YKK Frontreißverschluss
- // Brusttasche mit Patte und mit Versteckte Ausweis-Tasche
- // Vertikale Brusttasche mit wasserdichtem Reißverschluss
- // Versteckte Innentasche für Tablet/A4-Block
- // Doppelte Wetterschutzleiste mit Klett
- // 2 Taschen m. Reißverschluss
- // Abnehmbare Kapuze m. Kordel und Klettverstellung
- // Schulterverstärkung
- // Netzfutter für verbesserte Atmungsaktivität
- // Angepasster Schnitt an den Ärmeln für einen besseren Passform
- // Ärmel verstellbar mit Klettverschluss
- // Verstellbar im Bund
- // Zugang für Veredelung
- // Segmentierte EN ISO 20471 Reflexstreifen

DK VISIBLE XTREME STRETCH JAKKE

- // Tapede sømme
- // YKK lynlås i front
- // Brystlomme med klap, der indeholder ID-lomme
- // Vertikal brystlomme med coated lynlås
- // Skjult multifunktions lomme til tablet og notesbog (A4)
- // Dobbelt vindfang med gribeband
- // 2 lommer med lynlås
- // Justerbar aftagelig hætte med gribeband på bagsiden
- // Forstærkning på skuldre
- // Mesh foer for optimeret åndbarhed
- // Indsnit på ærmer for bedre pasform
- // Justering i ærmer med gribeband
- // Justerbar nederste kant
- // Adgang til ryprint
- // Segmenterede EN ISO 20471 certificerede reflekser



Windproof
Waterproof
Breathable



Stretch



Zip-in
Zip-out

ART. 182400R

EN VISIBLE XTREME STRETCH WAIST TROUSERS

- // Taped seams
- // Adjustable waist with hook & loop
- // Cordura® reinforcement on knee pocket
- // Polyamide reinforcements on back and leg opening
- // Adjustable legs with elastic and press buttons

D VISIBLE XTREME STRETCHBUNDHOSE

- // Nähte getaped
- // Verstellbar m. Klett im Bund
- // Corduraverstärkte Knietasche
- // Polyamidverstärkung an Gesäß und Beine
- // Verstellbar im Bein mit Elastik und Druckknöpfen

DK VISIBLE XTREME TALJEBUKSER

- // Tapede sømme
- // Justerbar talje med gribebånd
- // Cordura® forstærket knælomme
- // Polyamidforstærkning på ryg og ben
- // Justerbare ben med elastik og trykknop-lukning



Size XS - 5XL
Size L inner leg length: 84 cm / 33 in
Water column main fabric: > 20.000 mm H₂O
Breathability: > 5.000 g/m²/24h

EN 343 4 4 X EN ISO 20471 2 RIS-3279-TOM

033 042
 FL. ORANGE/ FL. YELLOW/
 BLACK BLACK

100% POLYESTER, 75D TWILL, 190 G/M²

Windproof
Waterproof
Breathable

Stretch

Zipper in
legs

Pockets for
knee pads

ART. 182401R

EN VISIBLE XTREME STRETCH COMBI TROUSERS

- // Taped seams
- // Adjustable waist with hook & loop
- // Cordura® reinforcement on knee pocket
- // Adjustable legs with elastic and press buttons
- // Detachable braces and back piece

D VISIBLE XTREME KOMBIOSE MIT STRETCH

- // Nähte getaped
- // Verstellbar m. Klett im Bund
- // Corduraverstärkte Knietasche
- // Verstellbar im Bein mit Elastik und Druckknöpfen
- // Abnehmbare Träger/Rücken

DK VISIBLE XTREME STRETCH KOMBI-BUKSER

- // Tapede sømme
- // Justerbar talje med gribebånd
- // Cordura® forstærket knælomme
- // Justerbare ben med elastik og trykknop-lukning
- // Aftagelige seler og rygstykke



Size XS - 5XL
Size L inner leg length: 84 cm / 33 in
Water column main fabric: > 20.000 mm H₂O
Breathability: > 5.000 g/m²/24h

EN 343 4 4 X EN ISO 20471 2 RIS-3279-TOM

033 042
 FL. ORANGE/ FL. YELLOW/
 BLACK BLACK

100% POLYESTER, 75D TWILL, 190 G/M²

Windproof
Waterproof
Breathable

Stretch

Detachable
braces

Zipper in
legs

Pockets for
knee pads

THE ELASTIC BRACES ARE EASILY FASTENED AND REMOVED WITH A ZIPPER AND LOOPS.



ART. 150015R

EN VISIBLE XTREME MIDLAYER ZIP-IN JACKET

- // Inserted through elastic loops in sleeves, neck and zipper in front
- // Chest pocket with zipper and hidden ID pocket
- // 2 side pockets with zipper
- // Extra back length

D VISIBLE XTREME MIDLAYER ZIPP-IN JACKE

- // Einzippbar durch Elastikschlaufen am Ärmel und am Nacken sowie Reißverschluss an Front
- // Vertikale Reißverschluss tasche auf der Brusttasche
- // 2 Seitentaschen mit Reißverschluss
- // Extra Rückenlänge

DK VISIBLE XTREME MIDLAYER ZIP-IN JAKKE

- // Indsættes via elastik loops i ærmer og nakke samt lynlås i front
- // Brystlomme med lynlås og skjult ID lomme
- // 2 sidelommer med lynlås
- // Ekstra ryglængde

Visible Xtreme
BY ELKA

Size XS - 5XL

Size L back length: 77 cm / 30 in

EN ISO 20471



030

FL.

ORANGE



040

FL.

YELLOW

100% POLYESTER. FLEECE. 240 G/M²
ZIP-IN JACKET FOR SHELL JACKETS
ART. 186000R / ART. 086004R.
Zip-in
Zip-out

ART. 150014R

EN VISIBLE XTREME ZIP-IN FLEECE

- // Reinforced shoulder and upper back
- // Breast pocket with zipper and plastic ID-holder
- // Lining inside - also in sleeves
- // Reflective tape with double stitching
- // Extra back length

D VISIBLE XTREME ZIPP-IN FLEECE

- // Verstärkung auf Schulter
- // Brusttasche mit Reißverschluss und ID-Tasche
- // Lining innen - auch in den Ärmeln
- // Doppelte Naht an den Reflexstreifen
- // Extra Rückenlänge

DK VISIBLE XTREME ZIP-IN FLEECE

- // Forstærkning på skuldre og øverste ryg
- // Brystlomme med lynlås og ID-lomme i plast
- // Indvendig lining - også i ærmer
- // Dobbeltstikninger på reflekser
- // Ekstra ryglængde

Visible Xtreme
BY ELKA

Size S - 5XL

Size L back length: 77 cm / 30 in

EN ISO 20471 RIS-3279-TOM



030

FL.

ORANGE



040

FL.

YELLOW

100% POLYESTER. FLEECE. 280 G/M²
ZIP-IN JACKET FOR SHELL JACKETS
ART. 186000R / ART. 086004R.
Zip-in
Zip-out

ELKARAINWEAR.DK

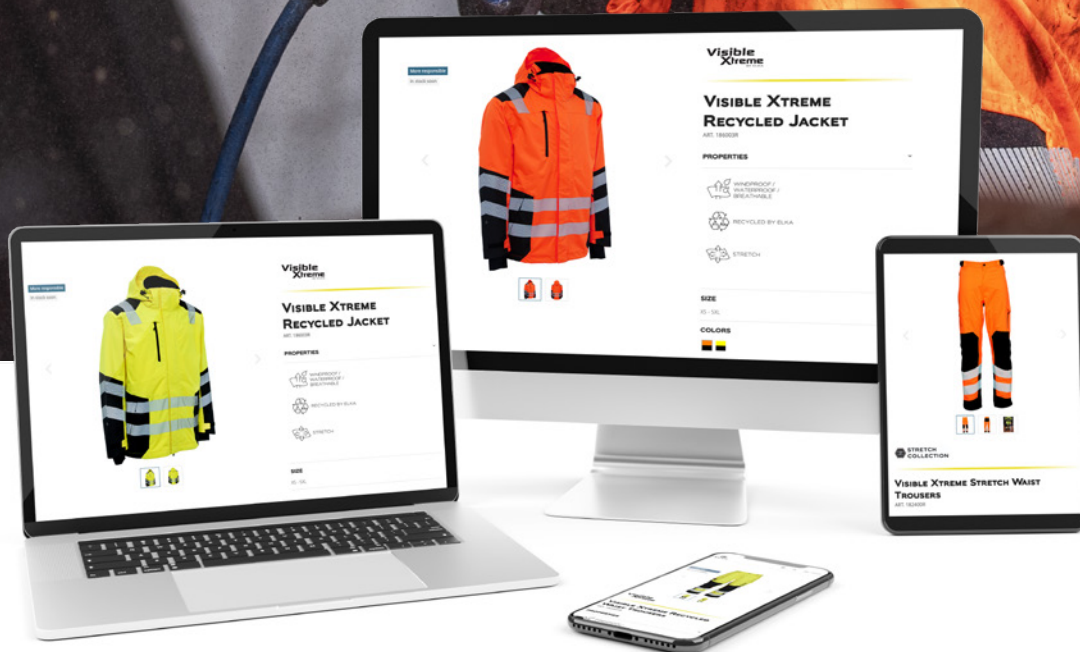

JOIN US ONLINE

Get your own login for ELKA's B2B webshop and enjoy these benefits:

- // We are always open – place your order anytime.
- // Start an order and complete it later – the items will remain in your cart for 15 days.
- // Reorder quickly and efficiently from your own favorite lists.
- // View the stock status for each item.
- // Easily find order history, invoices, and credit notes as needed.

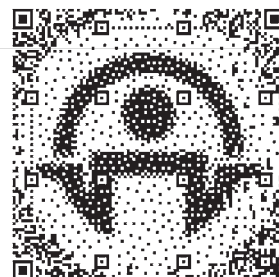

www.elkarainwear.dk

ART. 086100R

EN VISIBLE XTREME 2-IN-1 JACKET

- // Taped seams
- // Hidden/detachable hood
- // 2-way zipper and double storm flap with press buttons
- // Print access
- // Detachable lining

D VISIBLE XTREME 2-IN-1 JACKE

- // Nähte getaped
- // Abnehmbare/ verstellbare Kapuze
- // 2-Wege Reißverschluss und doppelte Wetterschutzleiste mit Druckknöpfen
- // Zugang für Veredelung
- // Herausnehmbares Futter

DK VISIBLE XTREME 2-IN-1 JAKKE

- // Tapede sømme
- // Skjult, aftagelig hætte
- // 2-vejs lynlås og dobbelt vindfang med trykknapper
- // Adgang til rygprint
- // Aftageligt for

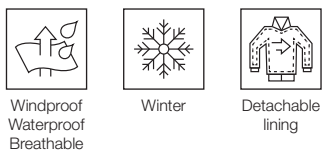

Visible Xtreme
BY ELKA

WATER COLUMN
8.000
MM

Size XS - 5XL
Size L back length: 77 cm / 30 in
Water column main fabric: > 8.000 mm H₂O
Breathability: > 5.000 g/m²/24h

EN 343 3 EN ISO 20471 3 RIS-3279-TOM

033 **042** **062**
 FL. ORANGE/ FL. YELLOW/ FL. RED/
 BLACK BLACK BLACK

100% POLYESTER. 300DX300D OXFORD.
190 G/M²

2-IN-1 JACKET.

ART. 082400R

EN VISIBLE XTREME WAIST TROUSERS

- // Taped seams
- // Cordura® knee reinforcement
- // Adjustable waist
- // 2 back pockets with flap
- // Zipper in legs in col. fl. orange and fl. yellow

D VISIBLE XTREME BUNDHOSE

- // Nähte getaped
- // Cordura® knieverstärkning
- // Verstellbar im Bund
- // 2 Gesäßtaschen
- // Reißverschluss am Bein in Farbe warn Gelb und warn Orange

DK VISIBLE XTREME TALJEBUKSER

- // Tapede sømme
- // Cordura® knæforstærkning
- // Justerbar talje
- // 2 baglommer med klap
- // Lynlås i ben i fl. orange og fl. gul

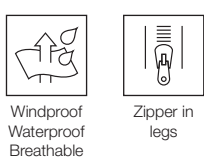

Visible Xtreme
BY ELKA

WATER COLUMN
8.000
MM

Size XS - 5XL
Size L inner leg length: 84 cm / 33 in
Water column main fabric: > 8.000 mm H₂O
Breathability: > 5.000 g/m²/24h

EN 343 3 EN ISO 20471 1 RIS-3279-TOM

033 **042** **062**
 FL. ORANGE/ FL. YELLOW/ FL. RED/
 BLACK BLACK BLACK

100% POLYESTER. 300DX300D OXFORD.
190 G/M²

**ATTENTION:
COLOR 062 IS WITHOUT
ZIPPER IN LEG.**

ART. 086005R

Visible Xtreme
BY ELKA

WATER COLUMN
8.000
MM

EN VISIBLE XTREME JACKET

- // Taped seams
- // Hidden hood
- // Extra back length
- // Storm flap with press buttons
- // Print access

D VISIBLE XTREME JACKE



- // Nähte getaped
- // Versteckte Kapuze
- // Extra Rückenlänge
- // Wetterschutzleiste mit Druckknöpfen an Front
- // Zugang für Veredelung

DK VISIBLE XTREME JAKKE

- // Tapede sømme
- // Skjult hætte
- // Ekstra ryglængde
- // Vindfang med trykknapper i front
- // Adgang til rygprint



Size S - 5XL
Size L back length: 81 cm / 32 in
Water column main fabric: > 8.000 mm H₂O
Breathability: > 5.000 g/m²/24h

EN 343 3 EN ISO 20471 RIS-3279-TOM
  

030 **040**
 FL. FL.
 ORANGE YELLOW

100% POLYESTER. 150DX150D OXFORD.
 150 G/M²





Windproof
Waterproof
Breathable



Less weight

ART. 082405R

Visible Xtreme
BY ELKA

WATER COLUMN
8.000
MM

EN VISIBLE XTREME TROUSERS

- // Taped seams
- // Elastic and drawstring in waist
- // Zipper and hook & loop in leg end
- // Double stitching on reflective tape
- // Tool pocket at righth leg

D VISIBLE XTREME BUNDHOSE



- // Nähte getaped
- // Elastik und Kordelzug im Bund
- // Reissverschluss und Klett am Bein
- // Doppelte Naht an den Reflexstreifen
- // Zollstock-Tasche am rechten Bein

DK VISIBLE XTREME TALJEBUKSER

- // Tapede sømme
- // Elastik i talje med snoretræk
- // Lynlås og gribebånd i ben
- // Dobbeltstikninger på reflekser
- // Tommestok-lomme på højre bukseben



Size S - 5XL
Size L inner leg length: 84 cm / 33 in
Water column main fabric: > 8.000 mm H₂O
Breathability: > 5.000 g/m²/24h

EN 343 3 EN ISO 20471 RIS-3279-TOM
  

030 **040**
 FL. FL.
 ORANGE YELLOW

100% POLYESTER. 150DX150D OXFORD.
 150 G/M²





Windproof
Waterproof
Breathable



Zipper in legs



Less weight

ART. 086004R

EN **VISIBLE XTREME JACKET**

- // Taped seams
- // 2-way zipper and double storm flap with press buttons
- // Hidden/detachable hood
- // Print access
- // Extra back length

D **VISIBLE XTREME JACKE**

- // Nähte getaped
- // 2-Wege Reißverschluss und doppelte Wetterschutzleiste mit Druckknöpfen
- // Versteckte, abnehmbare Kapuze
- // Zugang für Veredelung
- // Extra Rückenlänge

DK **VISIBLE XTREME JAKKE**

- // Tapede sømme
- // 2-vejs lynlås og dobbelt vindfang med trykknapper
- // Skjult aftagelig hætte
- // Mulighed for rygprint
- // Ekstra ryglængde



Windproof
Waterproof
Breathable



Zip-in
Zip-out



Visible Xtreme
BY ELKA

WATER COLUMN
8.000
MM

Size S - 5XL

Size L back length: 82 cm / 32 in
Water column main fabric: > 8.000 mm H₂O
Breathability: > 5.000 g/m²/24h



033 FL. ORANGE/ BLACK
042 FL. YELLOW/ BLACK

100% POLYESTER. 300DX300D OXFORD.
190 G/M²



READY FOR ZIP-IN JACKET
ART. 150015R / ART. 150014R /
ART. 150015 / ART. 150014 /
ART. 160014.

ART. 089900R

EN **VISIBLE XTREME BIB & BRACE**

- // Taped seams
- // Adjustable suspenders with Fix-lock
- // 2 back pockets with flap
- // Cordura® knee reinforcement
- // Adjustable waist

D **VISIBLE XTREME LATZHOSE**

- // Nähte getaped
- // Verstellbare Träger mit Fix-lock
- // 2 Gesäßtaschen mit Reißverschluss
- // Cordura® Knieverstärkung
- // Verstellbar im bund

DK **VISIBLE XTREME OVERALL**

- // Tapede sømme
- // Justerbare seler med Fix-lock
- // 2 baglommer med klap
- // Cordura® knæforstærkning
- // Justerbar talje



Windproof
Waterproof
Breathable



Visible Xtreme
BY ELKA

WATER COLUMN
8.000
MM

Size XS - 5XL

Size L inner leg length: 82 cm / 32 in
Water column main fabric: > 8.000 mm H₂O
Breathability: > 5.000 g/m²/24h



033 FL. ORANGE/ BLACK
042 FL. YELLOW/ BLACK

100% POLYESTER. 300DX300D OXFORD.
190 G/M²



ART. 117300R

EN VISIBLE XTREME SOFTSHELL JACKET

- /// Windproof, water repellent and breathable
- /// Detachable hood with string and hook & loop adjustment
- /// Reversed 2-way YKK zipper
- /// Sleeves with hook & loop adjustment and hand protection

D VISIBLE XTREME SOFTSHELLJACKE

- /// Winddicht, wasserabweisend und atmungsaktiv
- /// Abnehmbare Kapuze m. Kordel und Klettverstellung
- /// 2-Wege YKK-Reißverschluss
- /// Verstellbar Ärmel mit Klettverschluss und Handschutz

DK VISIBLE XTREME SOFTSHELL JAKKE

- /// Vindtæt, vandafvisende og åndbar
- /// Justerbar aftagelig hætte med gribebånd på bagsiden
- /// Reversed 2-vejs YKK-lynlås i front
- /// Justerbare ærmer med gribebånd og håndbeskyttelse



Detachable sleeves



Visible Xtreme BY ELKA **WATER COLUMN 8.000 MM**

Size XS - 5XL
Size L back length: 78 cm / 30.5 in
Water column main fabric: > 8.000 mm H₂O
Breathability: > 5.000 g/m²/24h

Jacket

EN ISO 20471 ² EN ISO 20471 ³ RIS-3279-TOM

XS-S M-5XL

Without sleeves

EN ISO 20471 ¹ EN ISO 20471 ²

XS-S M-5XL

033 **042**
 FL. ORANGE/ FL. YELLOW/
 BLACK BLACK

100% POLYESTER. 75D TWILL. FLEECE BACKING. 320 G/M²

ART. 116505R

EN VISIBLE XTREME SOFTSHELL JACKET

- /// Windproof, water repellent and breathable
- /// YKK main zipper
- /// Storm flap with hook & loop
- /// Chest pocket with zipper and hidden ID pocket
- /// Adjustable sleeves with hook & loop

D VISIBLE XTREME SOFTSHELLJACKE

- /// Winddicht, wasserabweisend und atmungsaktiv
- /// YKK Frontreißverschluss
- /// Wetterschutzleiste mit Klett
- /// Brusttasche mit Reißverschluss und versteckter Ausweistasche
- /// Ärmel verstellbar mit Klett

DK VISIBLE XTREME SOFTSHELL JAKKE

- /// Vindtæt, vandafvisende og åndbar
- /// YKK-lynlås i front
- /// Vindfang med gribebånd
- /// Brystlomme med lynlås og skjult ID lomme i plast
- /// Justering i ærmer med gribebånd



Visible Xtreme BY ELKA **WATER COLUMN 5.000 MM**

Size XS - 5XL
Size L back length: 78 cm / 30.5 in
Water column main fabric: > 5.000 mm H₂O
Breathability: > 3.000 g/m²/24h

EN ISO 20471 ² EN ISO 20471 ³ RIS-3279-TOM

XS-M L-5XL

033 **042**
 FL. ORANGE/ FL. YELLOW/
 BLACK BLACK

100% POLYESTER. 75D TWILL. FLEECE BACKING. 320 G/M²

ART. 086500R

EN VISIBLE XTREME SOFTSHELL JACKET

- // Windproof, water repellent and breathable
- // 3 pockets with zipper
- // Sleeves with hook & loop adjustment
- // Adjustable lower hem
- // 3M Reflective tape

D VISIBLE XTREME SOFTSHELLJACKE

- // Winddicht, wasserabweisend und atmungsaktiv
- // 3 Taschen mit Reißverschluss
- // Verstellbar Ärmel mit Klettverschluss
- // Kordelzug an untere Kante
- // 3M Reflexen

DK VISIBLE XTREME SOFTSHELL JAKKE

- // Vindtæt, vandafvisende og åndbar
- // 3 lommer med lynlås
- // Justerbare ærmer med gribebånd
- // Justerbar nederste kant
- // 3M reflekser



Detachable sleeves

Visible Xtreme
BY ELKA

WATER COLUMN
5.000
MM

Size XS - 5XL

Size L back length: 78 cm / 30.5 in
Water column main fabric: > 5.000 mm H₂O
Breathability: > 3.000 g/m²/24h

Jacket

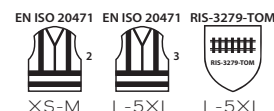

Without sleeves

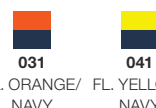
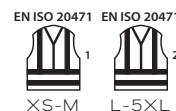

100% POLYESTER. TWILL. FLEECE BACKING. 310 G/M²



ART. 116504R

EN VISIBLE XTREME SOFTSHELL JACKET

- // Windproof, water repellent and breathable
- // Zipper and storm flap with hook & loop
- // Hidden pocket with zipper in storm flap
- // Extra length on back
- // Hook & loop adjustment in sleeves

D VISIBLE XTREME SOFTSHELLJACKE

- // Winddicht, wasserabweisend und atmungsaktiv
- // Reißverschluss und Wetterschutzleiste mit Klett
- // Versteckte Tasche mit Reißverschluss hinter der Wetterschutzleiste
- // Extra Rückenlänge
- // Klettverstellung am Ärmel

DK VISIBLE XTREME SOFTSHELL JAKKE

- // Vindtæt, vandafvisende og åndbar
- // Lynlås og vindfang med gribebånd
- // Skjult lynlåslomme i vindfang
- // Ekstra ryglængde
- // Justering i ærmer med gribebånd



Detachable sleeves

Visible Xtreme
BY ELKA

WATER COLUMN
5.000
MM

Size S - 5XL

Size L back length: 78 cm / 30.5 in
Water column main fabric: > 5.000 mm H₂O
Breathability: > 3.000 g/m²/24h

Jacket

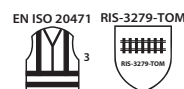

Without sleeves

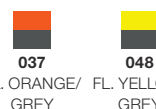

100% POLYESTER. TWILL. FLEECE BACKING. 310 G/M²



ART. 116514R

EN VISIBLE XTREME WINTER SOFTSHELL JACKET

- // Thermal lining
- // Detachable hood
- // Zipper and storm flap with hook & loop
- // Hidden pocket with zipper in storm flap
- // 2 Inside pockets

D VISIBLE XTREME SOFTSHELL WINTERJACKE

- // Thermofutter
- // Abnehmbare Kapuze
- // Reißverschluss und Wetterschutzleiste mit Klett
- // Versteckte Tasche mit Reißverschluss hinter der Wetterschutzleiste
- // 2 Innentasche

DK VISIBLE XTREME VINTER SOFTSHELL JAKKE

- // Termo-lining
- // Aftagelig hætte
- // Lynlås og vindfang med gribebånd
- // Skjult lynlåslomme i vindfang
- // 2 indvendige lommer



Winter



Detachable sleeves

Visible Xtreme BY ELKA

WATER COLUMN 5.000 MM

Size S - 5XL
Size L back length: 78 cm / 30.5 in
Water column main fabric: > 5.000 mm H₂O
Breathability: > 3.000 g/m²/24h

Jacket

EN ISO 20471 RIS-3279-TOM

Without sleeves

EN ISO 20471

037 048
 FL. ORANGE/ FL. YELLOW/
 GREY GREY

100% POLYESTER. TWILL. FLEECE BACKING. 310 G/M²

ART. 086101R

EN VISIBLE XTREME 2-IN-1 BOMBERJACKET

- // Taped seams
- // 2-way zipper
- // Double storm flap with press buttons
- // Hidden/ detachable hood
- // Print access

D VISIBLE XTREME 2-IN-1 PILOTENJACKE

- // Nähte getaped
- // 2-Wege Reißverschluss
- // Wetterschutzleiste mit Druckknöpfen
- // Versteckte Kapuze im Kragen
- // Zugang für Veredelung

DK VISIBLE XTREME 2-IN-1 PILOTJAKKE

- // Tapede sømme
- // 2-vejs lynlås
- // Vindfang med trykknapper
- // Skjult hætte
- // Mulighed for rygprint



Windproof
Waterproof
Breathable



Winter



Detachable lining

Visible Xtreme BY ELKA

WATER COLUMN 8.000 MM

Size XS - 5XL
Size L back length: 73 cm / 28.5 in
Water column main fabric: > 8.000 mm H₂O
Breathability: > 5.000 g/m²/24h

EN 343 EN ISO 20471 RIS-3279-TOM

033 042
 FL. ORANGE/ FL. YELLOW/
 BLACK BLACK

100% POLYESTER. 300DX300D OXFORD. 190 G/M²

2-IN-1 JACKET.

ART. 08800R

EN **VISIBLE XTREME WINTER THERMAL COVERALL**

- // Taped seams
- // Thermal lining
- // 2-way zipper and double storm flap with hook & loop
- // Black Cordura® knee reinforcement
- // Reinforced shoulder and elbow

D **VISIBLE XTREME WINTEROVERALL**

- // Nähte getaped
- // Thermo Futter
- // 2-Wege Reißverschluss und doppelte Wetterschutzleiste mit Klettverschluss
- // Schwarze Cordura® Knieverstärkung
- // Verstärkung auf Schulter und Ärmel

DK **VISIBLE XTREME VINTERKEDELDRAGT**

- // Tapede sømme
- // Termofoer
- // 2-vejs lynlås og dobbelt vindfang med gribebånd
- // Sort Cordura® knæforstærkning
- // Sort forstærkning på skuldre og ærmer



Winter



Zipper in legs



Visible Xtreme
BY ELKA

WATER COLUMN
8.000
MM

Size XS - 5XL

Size L inner leg length: 79 cm / 31 in
Water column main fabric: > 8.000 mm H₂O



033

FL. ORANGE/
BLACK



042

FL. YELLOW/
BLACK

100% POLYESTER. 300DX300D OXFORD.
190 G/M²



ART. 132201R

EN **VISIBLE XTREME CLASS 2 VEST**

- // Hook & loop closing

D **VISIBLE XTREME KLASSE 2 WESTE**

- // Klettverschluss

DK **VISIBLE XTREME KLASSE 2 VEST**

- // Lukkes med gribebånd



Visible Xtreme
BY ELKA

Size M - 4XL

Size L back length: 70 cm / 27.5 in

EN ISO 20471



030

FL. ORANGE



040

FL. YELLOW

100% POLYESTER. 120 G/M²







Working Xtreme

BY ELKA

EN

Working Xtreme is a series of high quality technical products, crafted for professionals in a classic and timeless fit and design. With the product wide assortment, it is always possible to find garments to keep you warm, as well as to protect against blistering wind and persistent rain.

The Scandinavian designed waterproof workwear is functional and durable and compares to regular workwear you can use all day long.

D

Working Xtreme ist eine Serie von technischen Qualitätsprodukten in einem klassischen sowie zeitlosem Design, welche für den Profi konzipiert sind. In unserer breiten Produkt-Auswahl finden sie immer Bekleidung, welche sie warmhält und gegen „Wind und Wetter“ schützt.

Die skandinavisch inspirierte Watterschutzkleidung ist funktionell, strapazierbar und ist wie „normale“ Workwear, den ganzen Tag einsetzbar.

DK

Working Xtreme er en serie af tekniske produkter af høj kvalitet, i en klassisk og tidløs pasform designet til professionelle. Med det brede produktsortiment er det altid muligt at finde tøj som kan holde dig varm, og samtidig beskytte dig mod stærk vind og vedvarende regn.

Det vandtætte arbejdstøj er i et skandinavisk design, funktionelt og slidstærkt og kan sammenlignes med almindeligt arbejdstøj, som kan bruges dagen lang.

ART. 186003

NEW

Working Xtreme
BY ELKA

WATER COLUMN
15.000
MM



Size XS - 5XL

Size L back length: 81 cm / 32 in

Water column main fabric: > 15.000 mm H₂O

Breathability: > 5.000 g/m²/24h

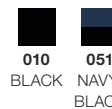

100% RECYCLED POLYESTER. 75D TWILL.
190 G/M²



RECYCLED by ELKA



EN WORKING XTREME RECYCLED JACKET

- // Taped seams
- // YKK main zipper
- // Double storm flap with hook & loop
- // Chest pocket with coated zipper containing hidden ID pocket
- // Hidden multifunction pocket for Tablet or notebook (A4)
- // 2 pockets with zipper
- // Detachable hood with string and hook & loop adjustment
- // Reinforced on shoulders
- // Mesh lining for optimized breathability
- // Sewn incisions on sleeves for better fit
- // Sleeves with hook & loop adjustment, hand protection and internal wind catch with thumb hole
- // Adjustable lower hem
- // Print access
- // Segmented black LOXY® reflective tape

D WORKING XTREME RECYCELTE JACKE

- // Nähte getaped
- // YKK-Frontreißverschluss
- // Doppelte Wetterschutzleiste mit Klett
- // Brusttasche mit wasserdichtem Reißverschluss und mit Versteckte Ausweis-Tasche
- // Versteckte Innentasche für Tablet/A4-Block
- // 2 Taschen mit Reißverschluss
- // Abnehmbare Kapuze mit Kordel und Klettverstellung
- // Schulterverstärkung
- // Netzfutter für verbesserte Atmungsaktivität
- // Angepasster Schnitt an den Ärmeln für einen besseren Passform
- // Verstellbar Ärmel mit Klettverschluss, Handschutz und Wetterschutzleiste innen mit Daumenloch
- // Verstellbar im Bund
- // Zugang für Veredelung
- // Segmentierte schwarze LOXY®-Reflektoren

DK WORKING XTREME RECYCLED JAKKE

- // Tapede sømme
- // YKK-lynlås i front
- // Dobbelt vindfang med gribebånd
- // Brystlomme med coated lynlås, der indeholder ID-lomme
- // Skjult multifunktions lomme til tablet og notesbog (A4)
- // 2 lommer med lynlås
- // Justerbar aftagelig hætte med gribebånd på bagsiden
- // Forstærkning på skuldre
- // Mesh foer for optimeret åndbarhed
- // Indsnit på ærmer for bedre pasform
- // Justerbare ærmer med gribebånd, håndbeskyttelse og indvendig vindfang med tommelfingerhul
- // Justerbar nedre kant
- // Adgang til rygprint
- // Segmenterede sorte LOXY®-reflekser



Windproof
Waterproof
Breathable



Recycled
by ELKA



Stretch

ART. 182403

NEW



Working Xtreme BY ELKA

WATER COLUMN 15.000 MM

<p>Size XS - 5XL</p> <p>Size L inner leg length: 82 cm / 32 in</p> <p>Water column main fabric: > 15.000 mm H₂O</p> <p>Breathability: > 5.000 g/m²/24h</p>
<p>EN 343 4 3 X</p> <p>OEKO TEX® STANDARD 100 2376-375 DTI</p>
<p>010 BLACK</p>
<p>100% RECYCLED POLYESTER. 75D TWILL. 190 G/M²</p>

RECYCLED by ELKA



EN WORKING XTREME RECYCLED WAIST TROUSERS

- // Taped seams
- // Adjustable waist with hook & loop
- // Vertical pockets with coated zippers
- // Side pocket with zipper and flap
- // Cordura® tool pocket
- // Cordura® reinforcement on knee pocket
- // Polyamide reinforcements on the back and leg opening
- // Legs with zipper
- // Adjustable legs with hook & loop
- // Segmented black LOXY® reflective tape

D WORKING XTREME RECYCLET BUNDSHOSE

- // Nähte getaped
- // Verstellbar m. Klett im Bund
- // Vertikale Taschen m. wasserdichten Reißverschlüssen und Patte
- // Seitentasche mit Reißverschluss und Patte
- // Cordura®-verstärkte Werkzeugtasche
- // Cordura®-verstärkte Knietasche
- // Polyamidverstärkung an Gesäß und Beine
- // Reißverschluss am Bein
- // Verstellbar im Bein mit Klett
- // Segmentierte schwarze LOXY®-Reflektoren

DK WORKING XTREME RECYCLED TALJEBUKSER

- // Tapede sømme
- // Justerbar talje med gribebånd
- // Vertikal lomme med coated lynlås
- // Sidelomme med lynlås og klap
- // Cordura® tommestok lomme
- // Cordura® forstærket knælomme
- // Polyamidforstærkning bagpå og i benene
- // Lynlås i ben
- // Justerbare ben med gribebånd
- // Segmenterede sorte LOXY®-reflekser



Windproof
Waterproof
Breathable



Recycled
by ELKA



Stretch



Zipper in
legs



Pockets for
knee pads

ART. 116503

NEW

Working Xtreme
BY ELKA

WATER COLUMN
8.000
MM



Size XS - 5XL

Size L back length: 78 cm / 30.5 in

Water column main fabric: > 8.000 mm H₂O

Breathability: > 3.000 g/m²/24h

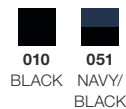

100% RECYCLED POLYESTER. 75D TWILL.
315 G/M²



RECYCLED by ELKA



EN WORKING XTREME RECYCLED SOFTSHELL JACKET

- // Windproof, water repellent and breathable
- // Reversed YKK main zipper and internal storm flap
- // Detachable hood with string and hook & loop adjustment
- // Chest pocket with zipper and hidden ID pocket
- // 2 pockets with reversed zipper
- // Sleeves with hook & loop adjustment, hand protection and internal wind catch with thumb hole
- // Adjustable lower hem
- // Extra length on back
- // Segmented black LOXY® reflective tape

D WORKING XTREME RECYCELTE SOFTSHELLJACKE

- // Winddicht, wasserabweisend und atmungsaktiv
- // Umgekehrter YKK-Frontreißverschluss und Wetterschutzleiste innen
- // Abnehmbare Kapuze mit Kordel und Klettverstellung
- // Brusttasche mit Reißverschluss und versteckter Ausweistasche
- // 2 Taschen mit Umgekehrter Reißverschluss
- // Verstellbar Ärmel mit Klettverschluss, Handschutz und Wetterschutzleiste innen mit Daumenloch
- // Verstellbar im Bund
- // Extra Lang hinten
- // Segmentierte schwarze LOXY®-Reflektoren

DK WORKING XTREME RECYCLED SOFTSHELL JAKKE

- // Vindtæt, vandafvisende og åndbar
- // Reversed YKK-lynlås i front og indvendigt vindfang
- // Justerbar aftagelig hætte med gribebånd på bagsiden
- // Brystlomme med lynlås og skjult ID lomme i plast
- // 2 lommer med reversed lynlås
- // Justerbare ærmer med gribebånd, håndbeskyttelse og indvendig vindfang med tommelfingerhul
- // Justerbar nedre kant
- // Ekstra ryglængde
- // Segmenterede sorte LOXY®-reflekser



Recycled by ELKA

ART. 106003

NEW

Working Xtreme
BY ELKA



Size XS - 5XL

Size L back length: 74 cm / 29 in



010
BLACK

100% RECYCLED POLYESTER 190 G/M².
100% POLYAMIDE RIPSTOP 40 G/M²



AT THE FRONT: PREMIUM INSULATION MADE FROM RECYCLED BOTTLES – COMFORTEMP® FROM FREUDENBERG.

RECYCLED by ELKA



EN WORKING XTREME HYBRID JACKET

- // YKK main zipper and chin protector
- // The padding is comfortemp® from Freudenberg
- // Chest pocket with zipper
- // 2 pockets with zipper
- // Padded front part
- // Sleeves with elastic piping and thumb hole
- // Elasticated lower hem

D WORKING XTREME HYBRID-JACKE

- // YKK-Frontreißverschluss und Kinnschluss
- // Die Wattierung ist comfortemp® von der Fa. Freudenberg
- // Brusttasche mit Reißverschluss
- // 2 Taschen mit Reißverschluss
- // Gepolsterte Vorderseite
- // Ärmelabschluss mit Kantenband und Daumenloch
- // Elastik an untere Kante

DK WORKING XTREME HYBRIDJAKKE

- // YKK-lynlås i front og hagebeskytter
- // Vatteringen er comfortemp® fra Freudenberg
- // Brystlomme med lynlås
- // 2 lommer med lynlås
- // Vatteret front
- // Ærmer med elastik kantbånd og tommelfingerhul
- // Elastik i nederste kant



Recycled
by ELKA

NEW

RECYCLED by ELKA

NEW HYBRID WORKWEAR SERIES



ELKA introduces water repellent, elastic, and flexible workwear trousers. The trousers fill the gap between regular workwear trousers and rain trousers – the perfect choice for versatile work where you alternate between indoor tasks and outdoor tasks, possibly in light rain.

ELKA's new hybrid stretch trousers are designed for all-day working comfort and made from a 4-way stretch material to ensure optimal freedom of movement.

The trousers are also available in fluorescent colors. See page 13.



**STANDARD
100**

**2376-375
DTI**

The trousers are
OEKO-TEX®
Standard 100
certified.

ART. **282404**

ART. **282404S**

ART. 282404

ART. 282404S

NEW

Working
Xtreme
BY ELKA

POCKETS FOR KNEE PADS:
ART. 3260 KNEE PADS ARE
SUITABLE, SEE PAGE 111.



ART. 282404:
Size EU 44 - 68
Size UK 28.5 - 52.5
Inner leg length: 82 cm / 32 in

ART. 282404S:
Size EU 23 - 31
Size UK 30.5 - 46.5
Inner leg length: 76 cm / 30 in



010
BLACK

90% RECYCLED POLYAMIDE.
10% ELASTANE. RIPSTOP. 260 G/M²



ART. 282404 TROUSERS CAN
EASILY BE LET DOWN TO EXTEND
THE LENGTH BY 4 CM / 1.5 IN.

SEE PAGE 32 FOR MORE INFO
ON THE NEW HYBRID ELKA
WORKWEAR.

RECYCLED by ELKA



EN WORKING XTREME RECYCLED WAIST TROUSERS

- // Water repellent
- // Vertical pockets with reversed zippers
- // Cordura® reinforcement tool pocket
- // Cordura® reinforcement on knee pocket
- // Two back pockets in Cordura® reinforcements
- // 2 front pockets
- // Leg length can be extended by 4 cm / 1.5 in (Art. 282404)

D WORKING XTREME RECYCLET BUNDHOSE

- // Wasserabweisend
- // Vertikale Taschen m. reversed Reißverschlüssen
- // Cordura®-verstärkte Werkzeugtasche
- // Cordura®-verstärkte Knietasche
- // 2 Gesäßtaschen aus Cordura®-Material
- // 2 Taschen
- // Die Beinlänge kann um 4 cm verlängert werden (Art. 282404)

DK WORKING XTREME RECYCLED TALJEBUKSER

- // Vandafvisende
- // Vertikal lomme med reversed lynlås
- // Cordura® forstærket tommestok lomme
- // Cordura® forstærket knælomme
- // 2 baglommer i Cordura® forstærkning bagpå
- // 2 frontlommer
- // Benlængde kan forlænges med 4 cm (Art. 282404)

Recycled
by ELKA

Stretch

Pockets for
knee pads

ART. 186100

Working Xtreme
BY ELKA

WATER COLUMN
20.000
MM

Size XS - 5XL
Size L back length: 81 cm / 32 in
Water column main fabric: > 20.000 mm H₂O

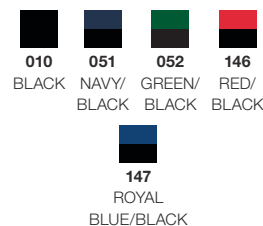
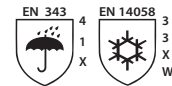

100% POLYESTER. 75D TWILL. 190 G/M²



PREMIUM INSULATION MADE FROM RECYCLED BOTTLES – COMFORTEMP® FROM FREUDENBERG.



EN WORKING XTREME STRETCH WINTER JACKET

- // Taped seams
- // Lightweight winter jacket with high end insulation
- // The padding is comfortemp® from Freudenberg
- // 2-way YKK main zipper
- // Chest pocket with flap containing hidden ID pocket
- // Vertical chest pocket with coated zipper
- // Hidden multifunction pocket for tablet or notebook (A4)
- // Double storm flap with hook & loop
- // 2 pockets with zipper and flaps
- // Detachable hood with string and hook & loop adjustment
- // Reinforced on shoulders
- // Sleeves with hook & loop adjustment and hand protection
- // Adjustable lower hem
- // Print access
- // Segmented black LOXY® reflective tape

D WORKING XTREME WINTERJACKE MIT STRETCH

- // Nähte getaped
- // Leichtgewichts-Winterjacke mit hoher Isolierfähigkeit
- // Die Wattierung ist comfortemp® von der Fa. Freudenberg
- // 2-Wege YKK-Frontreißverschluss
- // Brusttasche mit Patte und mit Versteckte Ausweis-Tasche
- // Vertikale Brusttasche mit Wasserdichtem Reißverschluss
- // Versteckte Innentasche für Tablet/A4-Block
- // Doppelte Wetterschutzleiste mit Klett
- // 2 Taschen m. Reißverschluss
- // Abnehmbare Kapuze m. Kordel und Klettverstellung
- // Schulterverstärkung
- // Verstellbar Ärmel mit Klettverschluss und mit Handschutz
- // Verstellbar im Bund
- // Zugang für Veredelung
- // Segmentierte schwarze LOXY®-Reflektoren

DK WORKING XTREME STRETCH VINTERJAKKE

- // Tapede sømme
- // Letvægtsvinterjakke med høj isoleringsevne
- // Vatteringen er comfortemp® fra Freudenberg
- // 2-vejs YKK-lynlås i front
- // Brystlomme med klap, der indeholder ID-lomme
- // Vertikal brystlomme med coated lynlås
- // Skjult multifunktions lomme til tablet og notesbog (A4)
- // Dobbelt vindfang med gribebånd
- // 2 lommer med lynlås
- // Justerbar aftagelig hætte med gribebånd på bagsiden
- // Forstærkning på skuldre
- // Justerbare ærmer med gribebånd og med håndbeskyttelse
- // Justerbar nederste kant
- // Adgang til rygprint
- // Segmenterede sorte LOXY®-reflekser



Stretch



Winter

ART. 186000

Working Xtreme
BY ELKA

WATER COLUMN
20.000
MM



Size XS - 5XL

Size L back length: 81 cm / 32 in
Water column main fabric: > 20.000 mm H₂O
Breathability: > 5.000 g/m²/24h

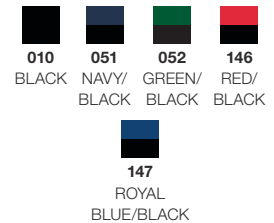

100% POLYESTER. 75D TWILL. 190 G/M²



READY FOR ZIP-IN JACKET
ART. 150015 / ART. 150014 /
ART. 160014.

WORKING XTREME

EN WORKING XTREME STRETCH JACKET

- // Taped seams
- // YKK main zipper
- // Chest pocket with flap containing hidden ID pocket
- // Vertical chest pocket with coated zipper
- // Hidden multifunction pocket for Tablet or notebook (A4)
- // Double storm flap with hook & loop
- // 2 pockets with zipper and flaps
- // Detachable hood with string and hook & loop adjustment
- // Reinforced on shoulders
- // Mesh lining for optimized breathability
- // Sewn incisions on sleeves for better fit
- // Sleeves with hook & loop adjustment
- // Adjustable lower hem
- // Print access
- // Segmented black LOXY® reflective tape

D WORKING XTREME STRETCHJACKE

- // Nähte getaped
- // YKK Frontreißverschluss
- // Brusttasche mit Patte und mit Versteckte Ausweis-Tasche
- // Vertikale Brusttasche mit wasserdichtem Reißverschluss
- // Versteckte Innentasche für Tablet/A4-Block
- // Doppelte Wetterschutzleiste mit Klett
- // 2 Taschen m. Reißverschluss
- // Abnehmbare Kapuze m. Kordel und Klettverstellung
- // Schulterverstärkung
- // Netzfutter für verbesserte Atmungsaktivität
- // Angepasster Schnitt an den Ärmeln für einen besseren Passform
- // Ärmel verstellbar mit Klettverschluss
- // Verstellbar im Bund
- // Zugang für Veredelung
- // Segmentierte schwarze LOXY®-Reflektoren

DK WORKING XTREME STRETCH JAKKE

- // Tapede sømme
- // YKK lynlås i front
- // Brystlomme med klap, der indeholder ID-lomme
- // Vertikal brystlomme med coated lynlås
- // Skjult multifunktions lomme til tablet og notesbog (A4)
- // Dobbelt vindfang med gribebånd
- // 2 lommer med lynlås
- // Justerbar aftagelig hætte med gribebånd på bagsiden
- // Forstærkning på skuldre
- // Mesh foer for optimeret åndbarhed
- // Indsnit på ærmer for bedre pasform
- // Justering i ærmer med gribebånd
- // Justerbar nederste kant
- // Adgang til rygprint
- // Segmenterede sorte LOXY®-reflekser



Windproof
Waterproof
Breathable



Stretch



Zip-in
Zip-out

ART. 182400

Working Xtreme
BY ELKA

WATER COLUMN
20.000
MM

EN WORKING XTREME STRETCH WAIST TROUSERS

- // Taped seams
- // Adjustable waist with hook & loop
- // Cordura® reinforcement on knee pocket
- // Polyamide reinforcements on the back and leg opening
- // Adjustable legs with elastic and press buttons

D WORKING XTREME STRETCHBUNDHOSE

- // Nähte getaped
- // Verstellbar m. Klett im Bund
- // Corduraverstärkte Knietasche
- // Polyamidverstärkung an Gesäß und Beine
- // Verstellbar im Bein mit Elastik und Druckknöpfen

DK WORKING XTREME STRETCH TALJEBUKSER

- // Tapede sømme
- // Justerbar talje med gribebånd
- // Cordura® forstærket knælomme
- // Polyamidforstærkning bagpå og i benene
- // Justerbare ben med elastik og trykknop-lukning



Size XS - 5XL
Size L inner leg length: 84 cm / 33 in
Water column main fabric: > 20.000 mm H₂O
Breathability: > 5.000 g/m²/24h

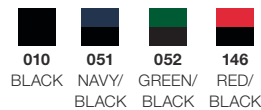

100% POLYESTER, 75D TWILL, 190 G/M²



Windproof
Waterproof
Breathable



Stretch



Zipper in
legs



Pockets for
knee pads

ART. 182401

Working Xtreme
BY ELKA

WATER COLUMN
20.000
MM

EN WORKING XTREME STRETCH COMBI TROUSERS

- // Taped seams
- // Adjustable waist with hook & loop
- // Cordura® reinforcement on knee pocket
- // Adjustable legs with elastic and press buttons
- // Detachable braces and back piece

D WORKING XTREME KOMBIHOSE MIT STRETCH

- // Nähte getaped
- // Verstellbar m. Klett im Bund
- // Corduraverstärkte Knietasche
- // Verstellbar im Bein mit Elastik und Druckknöpfen
- // Abnehmbare Träger/Rücken

DK WORKING XTREME STRETCH KOMBI-BUKSER

- // Tapede sømme
- // Justerbar talje med gribebånd
- // Cordura® forstærket knælomme
- // Justerbare ben med elastik og trykknop-lukning
- // Aftagelige seler og rygstykke



Size XS -5XL
Size L inner leg length: 84 cm / 33 in
Water column main fabric: > 20.000 mm H₂O
Breathability: > 5.000 g/m²/24h



100% POLYESTER, 75D TWILL, 190 G/M²



Windproof
Waterproof
Breathable



Stretch



Detachable
braces



Zipper in
legs



Pockets for
knee pads

THE ELASTIC BRACES ARE EASILY FASTENED AND REMOVED WITH A ZIPPER AND LOOPS.



ART. 186101

Working Xtreme
BY ELKA

WATER COLUMN
15.000
MM



Size XS - 5XL

Size L back length: 81 cm / 32 in
Water column main fabric: > 15.000 mm H₂O
Breathability: > 10.000 g/m²/24h



010 051 052
BLACK NAVY/ GREEN/
BLACK BLACK

90% POLYESTER. 10% ELASTHANE. 100D/
BACKING 40D. 200 G/M²



WORKING XTREME

**EN WORKING XTREME STRETCH
3 LAYER JACKET**

- // Taped seams
- // 3 layer jacket with outer fabric, membrane and lining laminated in one piece of fabric to make the jacket lighter.
- // 2-way YKK main zipper
- // Chest pocket with flap containing hidden ID pocket
- // Hidden multifunction pocket for tablet or notebook
- // Double storm flap with hook & loop
- // 2 pockets with coated zipper and flaps
- // Detachable hood with string and hook & loop adjustment
- // Sleeves with hook & loop adjustment and hand protection
- // Adjustable lower hem
- // Segmented black LOXY® reflective tape

**D 3-LAGEN-JACKE MIT
STRETCH**

- // Nähte getaped
- // 3-Lagen-Jacke mit Oberstoff, Membran und Lining in einem Material laminiert um die Jacke leichter zu machen
- // 2-Wege YKK-Frontreißverschluss
- // Brusttasche mit Patte und mit Versteckte Ausweis-Tasche
- // Versteckte Innentasche für Tablet/Block
- // Doppelte Wetterschutzleiste mit Klett
- // 2 Taschen m. wasserdichtem Reißverschluss
- // Abnehmbare Kapuze m. Kordel und Klettverstellung
- // Verstellbar Ärmel mit Klettverschluss und mit Handschutz
- // Verstellbar im Bund
- // Segmentierte schwarze LOXY®-Reflektoren

**DK WORKING XTREME STRETCH
3-LAGS-JAKKE**

- // Tapede sømme
- // 3-lags-jakke med yderstof, membran og for lamineret i ét stykke for at gøre jakken lettere
- // 2-vejs YKK-lynlås i front
- // Brystlomme med klap, der indeholder ID-lomme
- // Skjult multifunktions lomme til tablet og notesbog
- // Dobbelt vindfang med gribebånd
- // 2 lommer med coated lynlås
- // Justerbar aftagelig hætte med gribebånd på bagsiden
- // Justerbare ærmer med gribebånd og med håndbeskyttelse
- // Justerbar nederste kant
- // Segmenterede sorte LOXY®-reflekser



Windproof
Waterproof
Breathable



Stretch

ART. 150015

Working
Xtreme
BY ELKA

**EN WORKING XTREME
MIDLAYER ZIP-IN JACKET**

- // Inserted through elastic loops in sleeves neck and zipper in front
- // Chest pocket with zipper and hidden ID pocket
- // 2 side pockets with zipper
- // Extra back length

**D WORKING XTREME
MIDLAYER ZIPP-IN JACKE**

- // Einzipfbar durch Elastikschlaufen am Ärmel und am Nacken sowie Reißverschluss an Front
- // Vertikale Reißverschlussstasche auf der Brusttasche
- // 2 Seitentaschen mit Reißverschluss
- // Extra Rückenlänge

**DK WORKING XTREME
MIDLAYER ZIP-IN JAKKE**

- // Indsættes via elastik loops i ærmer og nakke samt lynlås i front
- // Brystlomme med lynlås og skjult ID lomme
- // 2 sidelommer med lynlås
- // Ekstra ryglængde



Size XS - 5XL Size L back length: 77 cm / 30 in
010 BLACK
100% POLYESTER. 240 G/M ²

**ZIP-IN JACKET FOR SHELL
JACKETS**
ART. 186000 / ART. 086004 /
ART. 186000R / ART. 086004R.



**ILLUMINATED REFLECTIVE
TAPE.**



Zip-in
Zip-out

ART. 160014

Working
Xtreme
BY ELKA

**EN WORKING XTREME
THERMAL ZIP-IN JACKET**

- // Zipper
- // 3 pockets with zipper
- // Ribbed collar and sleeves
- // Reinforced shoulders and sleeves
- // Extra back length

**D WORKING XTREME
THERMO ZIPP-IN JACKE**

- // Reißverschluss
- // 3 Taschen m. Reißverschluss
- // Rippbund am Kragen und Ärmel
- // Verstärkung an Schulter und Elbogen
- // Extra Rückenlänge

**DK WORKING XTREME TERMO
ZIP-IN JAKKE**

- // Lynlås
- // 3 lommer med lynlås
- // Forstærkning på skulder og albuer
- // Rib i krave og ærmer
- // Ekstra ryglængde



Size XS - 5XL Size L back length: 75 cm / 29.5 in
010 BLACK
210T POLYESTER TAFFETA. 100% POLYESTER PADDING. 250 G/M ²

**ZIP-IN JACKET FOR SHELL
JACKETS**
ART. 186000 / ART. 086004 /
ART. 186000R / ART. 086004R.



Zip-in
Zip-out

ART. 150014

EN WORKING XTREME FLEECE ZIP-IN JACKET

- // Reinforced shoulders and sleeves
- // Extra back length
- // Inserted through elastic loops in the sleeves and neck, and zipper in front
- // Polyester lining
- // Ribbed sleeves

D WORKING XTREME FLEECE ZIPP-IN JACKE

- // Verstärkung an Schulter und Elbogen
- // Extra Rückenlänge
- // Wird eingebaut durch Elastik-Schlaufen am Ärmel und am Nacken sowie Reißverschluss am front
- // Polyesterwattierung
- // Rippbund am Ärmel

DK WORKING XTREME FLEECE ZIP-IN JAKKE

- // Forstærkning på skulder og albuer
- // Ekstra ryglængde
- // Indsættes via elastikloops i ærmer og nakke samt lynlås i front
- // Polyesterfor
- // Rib i ærmer



Zip-in
Zip-out



Working Xtreme
BY ELKA

<p>Size XS - 5XL Size L back length: 77 cm / 30 in</p>
<p>010 BLACK</p>
<p>100% POLYESTER. ANTI PEELING FLEECE. 280 G/M²</p>
<p></p>

ZIP-IN JACKET FOR SHELL JACKETS
ART. 186000 / ART. 086004 /
ART. 186000R / ART. 086004R.

ART. 150016

EN WORKING XTREME MIDLAYER FLEECE JACKET

- // Used as a jacket or as a mid layer
- // Reversed 2-way YKK zipper and chin protector
- // Reinforcements on the shoulders and the sleeves
- // Segmented LOXY® reflective tape by shoulders in front and at the bottom of the back
- // Extra back length

D WORKING XTREME MIDLAYER FLEECEJACKE

- // Wird als Jacke oder Zwischenschicht verwendet
- // 2-Wege YKK-Reißverschluss und Kinnschutz
- // Verstärkung an den Schultern und Ärmeln
- // Segmentierte LOXY®-Reflektoren vorne bei den Schultern und unten am Rücken
- // Extra Rückenlänge

DK WORKING XTREME MIDLAYER FLEECE JAKKE

- // Anvendes som jakke eller mellemlag
- // Reversed 2-vejs YKK-lynslås og hagebeskytter
- // Forstærkning på skuldrene og på ærmerne
- // Segmenterede LOXY®-reflekser foran ved skuldrene og nederst på ryggen
- // Ekstra ryglængde



Working Xtreme
BY ELKA

<p>Size XS - 5XL Size L back length: 74 cm / 29 in</p>
<p>OEKO TEX STANDARD 100 2376-375 DTI</p>
<p>098 GREY MELANGE</p>
<p>100% POLYESTER. FLEECE KNITTED FABRIC. 220 G/M²</p>
<p></p>

WORKS IDEALLY AS MIDLAYER UNDER ELKA'S 3-LAYER JACKET
ART. 186101.

ART. 086002

Working Xtreme BY ELKA

WATER COLUMN 8.000 MM

EN WORKING XTREME JACKET

- // Taped seams
- // 2-way zipper
- // Double storm flap with press buttons
- // Hidden detachable hood
- // Print access

D WORKING XTREME JACKE

- // Nähte getaped
- // 2-Wege Reißverschluss
- // Doppelte Wetterschutzleiste mit Druckknöpfen
- // Versteckte abnehmbare Kapuze
- // Zugang für Veredelung

DK WORKING XTREME JAKKE

- // Tapede sømme
- // 2-vejs lynlås
- // Dobbelt vindfang med trykknapper
- // Skjult aftagelig hætte
- // Mulighed for rygprint



Size XS - 5XL
 Size L back length: 76 cm / 30 in
 Water column main fabric: > 8.000 mm H₂O
 Breathability: > 5.000 g/m²/24h

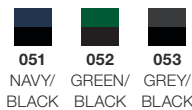

100% POLYESTER. 300DX300D OXFORD.
190 G/M²



Windproof
Waterproof
Breathable

ART. 086103

Working Xtreme BY ELKA

WATER COLUMN 8.000 MM

EN WORKING XTREME 2-IN-1 JACKET

- // Taped seams
- // 2-way zipper
- // Double storm flap with press buttons
- // Hidden detachable hood
- // Print access

D WORKING XTREME 2-IN-1 JACKE

- // Nähte getaped
- // 2-Wege Reißverschluss
- // Doppelte Wetterschutzleiste mit Druckknöpfen
- // Versteckte abnehmbare Kapuze
- // Zugang für Veredelung

DK WORKING XTREME 2-IN-1 JAKKE

- // Tapede sømme
- // 2-vejs lynlås
- // Dobbelt vindfang med trykknapper
- // Skjult aftagelig hætte
- // Mulighed for rygprint



Size XS - 5XL
 Size L back length: 77 cm / 30 in
 Water column main fabric: > 8.000 mm H₂O
 Breathability: > 5.000 g/m²/24h

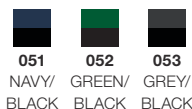

100% POLYESTER. 300DX300D OXFORD.
190 G/M²



2-IN-1 JACKET.



Windproof
Waterproof
Breathable



Winter



Detachable
lining

ART. 082402

EN WORKING XTREME WAIST TROUSERS

- // Taped seams
- // Cordura® knee reinforcement
- // Adjustable waist
- // 2 pockets with zipper
- // Double tool pocket

D WORKING XTREME BUNDHOSE

- // Nähte getaped
- // Cordura® knieverstärkung
- // Verstellbar im Bund
- // 2 Taschen mit Reißverschluss
- // Zollstocktasche

DK WORKING XTREME TALJEBUKSER

- // Tapede sømme
- // Cordura® knæforstærkning
- // Justerbar talje
- // 2 Lommer med lynlås
- // Tømmestok-lomme



Working Xtreme
BY ELKA

WATER COLUMN
8.000
MM

Size XS - 5XL

Size L inner leg length: 84 cm / 33 in
Water column main fabric: > 8.000 mm H₂O
Breathability: > 5.000 g/m²/24h

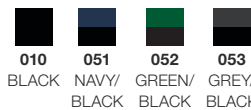

100% POLYESTER. 300DX300D OXFORD.
190 G/M²



Windproof
Waterproof
Breathable



Zipper in
legs

ART. 089902

EN WORKING XTREME BIB & BRACE

- // Taped seams
- // Adjustable suspenders with Fix-lock
- // Cordura® knee reinforcement
- // 2 pockets with zipper
- // Tool pocket

D WORKING XTREME LATZHOSE

- // Nähte getaped
- // Verstellbare Träger mit Fix-lock
- // Cordura® knieverstärkung
- // 2 Taschen mit Reißverschluss
- // Zollstocktasche

DK WORKING XTREME OVERALL

- // Tapede sømme
- // Justerbare seler med Fix-lock
- // Cordura® knæforstærkning
- // 2 lommer med lynlås
- // Tømmestok-lomme



Working Xtreme
BY ELKA

WATER COLUMN
8.000
MM

Size XS - 5XL

Size L inner leg length: 82 cm / 32 in
Water column main fabric: > 8.000 mm H₂O
Breathability: > 5.000 g/m²/24h



100% POLYESTER. 300DX300D OXFORD.
190 G/M²



Windproof
Waterproof
Breathable

ART. 086003

Working Xtreme BY ELKA

WATER COLUMN 8.000 MM

EN WORKING XTREME JACKET

- // Taped seams
- // 2-way zipper
- // Hidden detachable hood
- // Double storm flap with press buttons
- // Print access

D WORKING XTREME JACKE

- // Nähte getaped
- // 2-Wege Reißverschluss
- // Versteckte abnehmbare Kapuze
- // Doppelte Wetterschutzleiste mit Druckknöpfen
- // Zugang für Veredelung

DK WORKING XTREME JAKKE

- // Tapede sømme
- // 2-vejs lynlås
- // Skjult aftagelig hætte
- // Dobbelt vindfang med trykknapper
- // Mulighed for rygprint



<p>Size XS - 5XL</p> <p>Size L back length: 76 cm / 30 in</p> <p>Water column main fabric: > 8.000 mm H₂O</p> <p>Breathability: > 5.000 g/m²/24h</p>
<p>010</p> <p>BLACK</p>
<p>100% POLYESTER, 300DX300D OXFORD.</p> <p>190 G/M²</p>



Windproof
Waterproof
Breathable

ART. 082403

Working Xtreme BY ELKA

WATER COLUMN 8.000 MM

EN WORKING XTREME COMBI TROUSERS

- // Taped seams
- // Adjustable waist
- // Knee pocket with Cordura® reinforcement
- // Reinforcement on the inside of the leg
- // Detachable braces and back piece

D WORKING XTREME KOMBI HOSE

- // Nähte getaped
- // Justierbar im Bund mit Elastik
- // Knietasche mit Cordura® Verstärkung
- // Verstärkung an der Innenseite des Beins
- // 2 Taschen mit Reißverschluss

DK WORKING XTREME KOMBI BUKSER

- // Tapede sømme
- // Justerbar talje med elastik
- // Knælommer med Cordura® forstærkning
- // Forstærkning på inderside af ben
- // Aftagelige seler og rygstykke



<p>Size XS - 5XL</p> <p>Size L inner leg length: 84 cm / 33 in</p> <p>Water column main fabric: > 8.000 mm H₂O</p> <p>Breathability: > 5.000 g/m²/24h</p>
<p>010</p> <p>BLACK</p>
<p>100% POLYESTER, 300DX300D OXFORD.</p> <p>190 G/M²</p>



Windproof
Waterproof
Breathable



Detachable
braces



Detachable
pockets



Zipper in
legs



Pockets for
knee pads

ART. **086005**

EN WORKING XTREME JACKET

- // Taped seams
- // Hidden hood
- // Storm flap with press buttons
- // Sleeves with hook & loop adjustment
- // Print access

D WORKING XTREME JACKE

- // Nähte getaped
- // Versteckte Kapuze
- // Wetterschutzleiste mit Druckknöpfen an Front
- // Ärmel verstellbar mit Klettverschluss
- // Zugang für Veredelung

DK WORKING XTREME JAKKE

- // Tapede sømme
- // Skjult hætte
- // Vindfang med trykknapper i front
- // Justerbare ærmer med gribebånd
- // Adgang til rygprint



Working Xtreme
BY ELKA

WATER COLUMN
8.000
MM

Size XS - 5XL

Size L back length: 81 cm / 32 in
Water column main fabric: > 8.000 mm H₂O
Breathability: > 5.000 g/m²/24h



010
BLACK

100% POLYESTER. 150DX150D OXFORD.
150 G/M²



Windproof
Waterproof
Breathable



Less
weight

ART. **082405**

EN WORKING XTREME WAIST TROUSERS

- // Taped seams
- // Elastic and drawstring in waist
- // Zipper and hook & loop in leg end
- // Tool pocket at righth leg
- // 0,5 cm reflective piping

D WORKING XTREME BUNDHOSE

- // Nähte getaped
- // Elastik und Kordelzug über Body
- // Reissverschluss und Klett am Bein
- // Zollstock-Tasche am rechten Bein
- // 0,5 cm Reflex Applikationen

DK WORKING XTREME TALJEBUKSER

- // Tapede sømme
- // Elastik i talje med snoretæk
- // Lynlås og gribebånd i ben
- // Tommestok lomme på højre bukseben
- // 0,5 cm refleks detaljer



Working Xtreme
BY ELKA

WATER COLUMN
8.000
MM

Size XS - 5XL

Size L inner leg length: 84 cm / 33 in
Water column main fabric: > 8.000 mm H₂O
Breathability: > 5.000 g/m²/24h



010
BLACK

100% POLYESTER. 150DX150D OXFORD.
150 G/M²



Windproof
Waterproof
Breathable



Zipper in
legs



Less
weight

ART. 086004

Working Xtreme BY ELKA

WATER COLUMN 8.000 MM

EN WORKING XTREME JACKET

- // Taped seams
- // 2-way zipper and double storm flap with press buttons
- // Hidden/detachable hood
- // Print access
- // Reinforced shoulder and elbow

D WORKING XTREME JACKE

- // Nähte getaped
- // 2-Wege Reißverschluss und doppelte Wetterschutzleiste mit Druckknöpfen
- // Versteckte, abnehmbare Kapuze
- // Zugang für Veredelung
- // Verstärkung an Schulter und Ärmel

DK WORKING XTREME JAKKE

- // Tapede sømme
- // 2-vejs lynlås og dobbelt vindfang med trykknapper
- // Skjult aftagelig hætte
- // Adgang til rygprint
- // Forstærkning på skulder og ærmer



Windproof
Waterproof
Breathable



Zip-in
Zip-out

Size XS - 5XL
Size L back length: 82 cm / 32 in
Water column main fabric: > 8.000 mm H₂O
Breathability: > 5.000 g/m²/24h



100% POLYESTER, 300DX300D OXFORD.
190 G/M²



READY FOR ZIP-IN JACKET
ART. 150015 / ART. 150014 /
ART. 160014.

ART. 086104

Working Xtreme BY ELKA

WATER COLUMN 8.000 MM

EN WORKING XTREME 2-IN-1 BOMBER JACKET

- // Taped seams
- // 2-way zipper and double windbreak with press buttons
- // Hidden/detachable hood
- // Print access
- // Detachable thermal lining

D WORKING XTREME 2-IN-1 PILOTENJACKE

- // Nähte getaped
- // 2-Wege Reißverschluss und doppelte Wetterschutzleiste mit Druckknöpfen
- // Versteckte, abnehmbare Kapuze
- // Zugang für Veredelung
- // Herausnehmbares Thermofutter

DK WORKING XTREME 2-IN-1 PILOT JAKKE

- // Tapede sømme
- // 2-vejs lynlås og dobbelt vindfang med trykknapper
- // Skjult aftagelig hætte
- // Adgang til rygprint
- // Aftageligt termofor



Windproof
Waterproof
Breathable



Winter



Detachable
lining

Size XS - 5XL
Size L back length: 73 cm / 28.5 in
Water column main fabric: > 8.000 mm H₂O
Breathability: > 5.000 g/m²/24h



100% POLYESTER, 300DX300D OXFORD.
190 G/M²



2-IN-1 JACKET.

ART. 088002

EN WORKING XTREME WINTER THERMAL COVERALL

- // Taped seams
- // Thermal lining
- // 2-way zipper
- // Double storm flap with hook & loop
- // Cordura® knee reinforcement

D WORKING XTREME WINTEROVERALL

- // Nähte getaped
- // Thermofutter
- // 2-Wege Reißverschluss
- // Doppelte Wetterschutzleiste mit Klett
- // Cordura® Knieverstärkung

DK WORKING XTREME VINTERKEDELDRAGT

- // Tapede sømme
- // Termofoor
- // 2-vejs lynlås
- // Dobbelt vindfang med gribebånd
- // Cordura® knæforstærkning



Winter



Zipper in legs



Working Xtreme
BY ELKA

WATER COLUMN
8.000
MM

Size XS - 5XL

Size L inner leg length: 79 cm / 31 in
Water column main fabric: > 8.000 mm H₂O



053
GREY/
BLACK



057
STRONG
BLUE/BLACK

100% POLYESTER. 300DX300D OXFORD.
190 G/M²



ART. 088002W

EN WORKING XTREME WOMEN WINTER THERMAL COVERALL

- // Taped seams
- // Thermal lining
- // 2-way zipper
- // Double storm flap with hook & loop
- // Cordura® knee reinforcement

D WORKING XTREME WINTEROVERALL DAME

- // Nähte getaped
- // Thermofutter
- // 2-Wege Reißverschluss
- // Doppelte Wetterschutzleiste mit Klett
- // Cordura® Knieverstärkung

DK WORKING XTREME VINTERKEDELDRAGT KVINDE

- // Tapede sømme
- // Termofoor
- // 2-vejs lynlås
- // Dobbelt vindfang med gribebånd
- // Cordura® knæforstærkning



Winter



Zipper in legs



Working Xtreme
BY ELKA

WATER COLUMN
8.000
MM

Size XS - 3XL

Size L inner leg length: 74 cm / 29 in
Water column main fabric: > 8.000 mm H₂O



053
GREY/
BLACK

100% POLYESTER. 300DX300D OXFORD.
190 G/M²



ART. 088004

NEW



Working Xtreme
BY ELKA

WATER COLUMN
15.000
MM

Size XS - 5XL

Size L inner leg length: 79 cm / 31 in
Water column main fabric: > 15.000 mm H₂O



090
BLACK/
FL. YELLOW

100% POLYESTER. 300D TWILL. 210 G/M²



THIS PRODUCT IS EN 342-CERTIFIED, THERMAL INSULATION VALUE M²K/W 0.287 / CLO 1.85, AFTER 25 WASHES AT 60 DEGREES.

PREMIUM INSULATION MADE FROM RECYCLED BOTTLES – COMFORTEMP® FROM FREUDENBERG.

EN WORKING XTREME WINTER THERMAL COVERALL

- // Taped seams
- // The padding is comfotemp® from Freudenberg
- // Detachable hood with string and hook & loop adjustment
- // 2-way zipper and double storm flap with hook & loop
- // Vertical chest pocket with zipper containing hidden ID pocket
- // Sleeves with hook & loop adjustment, hand protection and internal wind catch with thumb hole
- // Stretch in the back for better freedom of movement
- // Inside pocket with hook & loop and penholder
- // Hidden Napoleon pocket with smartphone pocket and double pen holder
- // 2 Chest pockets, 2 side pockets and 2 thigh pockets
- // Reinforcement on shoulders, forearms, ankles and at the back
- // Cordura® reinforcement on knee pocket
- // Tool pocket in durable fabric
- // Exterior belt loops and detachable belt
- // Extra-long zipper, hook & loop, and storm flap in legs
- // Segmented black LOXY® reflective tape on arm, leg, shoulder and back

D WORKING XTREME WINTEROVERALL

- // Nähte getaped
- // Die Wattierung ist comfotemp® von der Fa. Freudenberg
- // Abnehmbare Kapuze m. Kordel und Klettverstellung
- // 2-Wege Reißverschluss und doppelte Wetterschutzleiste mit Klett
- // Vertikale Brusttasche mit Reißverschluss und mit Versteckte Ausweis-Tasche
- // Verstellbar Ärmel mit Klettverschluss, Handschutz und Wetterschutzleiste innen mit Daumenloch
- // Stretch Material im Rücken erhöht die Bewegungsfreiheit
- // Innentasche mit Klett und Stifthalter
- // Versteckte Napoleon-Tasche mit Smartphone-Tasche und doppeltem Stifthalter
- // 2 Brusttasche, 2 Seitentaschen und 2 Schenkeltaschen
- // Verstärkung an Schultern, Unterarmen, Knöcheln und Gesäß
- // Cordura®-verstärkte Knietasche
- // Werkzeugtasche in robustem Material
- // Äußere Gürtelschlaufen und abnehmbarer Gürtel
- // Extra langer Reißverschluss am Bein, Klettverschluss und wetterschutzleiste
- // Segmentierte schwarze LOXY®-Reflektoren am Arm, Bein, Schulter und Rücken

DK WORKING XTREME VINTERKEDELDRAGT

- // Tapede sømme
- // Vatteringen er comfotemp® fra Freudenberg
- // Justerbar aftagelig hætte med gribebånd på bagsiden
- // 2-vejs lynlås og dobbelt vindfang med gribebånd
- // Vertikal brystlomme med lynlås, der indeholder ID-lomme
- // Justerbare ærmer med gribebånd, håndbeskyttelse og indvendig vindfang med tommelfingerhul
- // Stretch i ryggen for øget bevægelsesfrihed
- // Indvendig lomme med gribebånd og penholder
- // Skjult Napoleon-lomme med smartphonelomme og dobbelt penholder
- // 2 brystlommer, 2 sidelommer og 2 lårlommer
- // Forstærkning på skuldre, underarme, ankler og bagpå
- // Cordura® forstærket knælomme
- // Tommestok-lomme i forstærket metervare
- // Udvendige bæltestropper og aftageligt bælte
- // Ekstralang lynlås, gribebånd og vindfang i ben
- // Segmenterede sorte LOXY®-reflekser på ærmer, skuldre, ben og ryg



Stretch



Winter



Zipper in legs



Pockets for knee pads

ART. 088004W

NEW



Working Xtreme
BY ELKA

WATER COLUMN
15.000
MM

Size XS - 3XL

Size L inner leg length: 75 cm / 29.5 in
Water column main fabric: > 15.000 mm H₂O



089
BLACK/
FL. RED

100% POLYESTER. 300D TWILL. 210 G/M²



THIS PRODUCT IS EN 342-CERTIFIED, THERMAL INSULATION VALUE M²K/W 0.287 / CLO 1.85, AFTER 25 WASHES AT 60 DEGREES.

PREMIUM INSULATION MADE FROM RECYCLED BOTTLES – COMFORTEMP® FROM FREUDENBERG.

EN WORKING XTREME WOMEN WINTER THERMAL COVERALL

- // Taped seams
- // The padding is comfortemp® from Freudenberg
- // Detachable hood with string and hook & loop adjustment
- // 2-way zipper and double storm flap with hook & loop
- // Vertical chest pocket with zipper containing hidden ID pocket
- // Sleeves with hook & loop adjustment, hand protection and internal wind catch with thumb hole
- // Stretch in the back for better freedom of movement
- // Inside pocket with hook & loop and penholder
- // Hidden Napoleon pocket with smartphone pocket and double pen holder
- // 2 Chest pockets, 2 side pockets and 1 thigh pocket
- // Reinforcement on shoulders, forearms, ankles and at the back
- // Cordura® reinforcement on knee pocket
- // Exterior belt loops and detachable belt
- // Extra-long zipper, hook & loop, and storm flap in legs
- // Segmented black LOXY® reflective tape on arm, leg, shoulder and back

D WORKING XTREME WINTEROVERALL DAME

- // Nähte getaped
- // Die Wattierung ist comfortemp® von der Fa. Freudenberg
- // Abnehmbare Kapuze m. Kordel und Klettverstellung
- // 2-Wege Reißverschluss und doppelte Wetterschutzleiste mit Klett
- // Vertikale Brusttasche mit Reißverschluss und mit Versteckte Ausweis-Tasche
- // Verstellbar Ärmel mit Klettverschluss, Handschutz und Wetterschutzleiste innen mit Daumenloch
- // Stretch Material im Rücken erhöht die Bewegungsfreiheit
- // Innentasche mit Klett und Stifthalter
- // Versteckte Napoleon-Tasche mit Smartphone-Tasche und doppeltem Stifthalter
- // 2 Brusttasche, 2 Seitentaschen und 1 Schenkeltasche
- // Verstärkung an Schultern, Unterarmen, Knöcheln und Gesäß
- // Cordura®-verstärkte Knietasche
- // Äußere Gürtelschlaufen und abnehmbarer Gürtel
- // Extra langer Reißverschluss am Bein, Klettverschluss und wetterschutzleiste
- // Segmentierte schwarze LOXY®-Reflektoren am Arm, Bein, Schulter und Rücken

DK WORKING XTREME VINTERKEDELDRAGT KVINDE

- // Tapede sømme
- // Vatteringen er comfortemp® fra Freudenberg
- // Justerbar aftagelig hætte med gribebånd på bagsiden
- // 2-vejs lynlås og dobbelt vindfang med gribebånd
- // Brystlomme med reversed lynlås, der indeholder ID-lomme
- // Justerbare ærmer med gribebånd, håndbeskyttelse og indvendig vindfang med tommelfingerhul
- // Stretch i ryggen for øget bevægelsesfrihed
- // Indvendig lomme med gribebånd og penholder
- // Skjult Napoleon-lomme med smartphonelomme og dobbelt penholder
- // 2 brystlommer, 2 sidelommer og 1 lårlomme
- // Forstærkning på skuldre, underarme, ankler og bagpå
- // Cordura® forstærket knælomme
- // Udvendige bæltestropper og aftageligt bælte
- // Ekstralang lynlås, gribebånd og vindfang i ben
- // Segmenterede sorte LOXY®-reflekser på ærmer, skuldre, ben og ryg



Stretch



Winter



Zipper in legs



Pockets for knee pads

ART. 117301

NEW

Working
Xtreme
BY ELKAWATER COLUMN
8.000
MM**EN WORKING XTREME WINTER
SOFTSHELL JACKET**

- // Windproof and water repellent
- // Detachable hood with string and hook & loop adjustment
- // Reversed 2-way YKK zipper
- // Sleeves with hook & loop adjustment and hand protection

**D WORKING XTREME
SOFTSHELL WINTERJACKE**

- // Winddicht und wasserabweisend
- // Abnehmbare Kapuze m. Kordel und Klettverstellung
- // Reversed 2-Wege YKK-Reißverschluss
- // Verstellbar Ärmel mit Klettverschluss und Handschutz

**DK WORKING XTREME VINTER
SOFTSHELL JAKKE**

- // Vindtæt og vandafvisende
- // Justerbar aftagelig hætte med gribebånd på bagsiden
- // Reversed 2-vejs YKK-lynlås i front
- // Justerbare ærmer med gribebånd og håndbeskyttelse



Winter

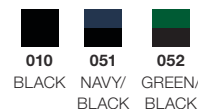

Size XS - 5XL

Size L back length: 78 cm / 30.5 in
Water column main fabric: > 8.000 mm H₂O100% POLYESTER. 75D TWILL. FLEECE
BACKING. 320 G/M²

**PREMIUM INSULATION MADE
FROM RECYCLED BOTTLES
- COMFORTEMP® FROM
FREUDENBERG.**

ART. 116500

Working
Xtreme
BY ELKAWATER COLUMN
5.000
MM**EN WORKING XTREME
SOFTSHELL JACKET**

- // Windproof, water repellent and breathable
- // Adjustable lower hem
- // Sleeves with hook & loop adjustment
- // Detachable hood
- // Inside pocket with zipper

**D WORKING XTREME
SOFTSHELLJACKE**

- // Winddicht, wasserabweisend und atmungsaktiv
- // Verstellbar im Bund
- // Ärmel verstellbar mit Klettverschluss
- // Abnehmbare Kapuze
- // Innentasche mit Reißverschluss

**DK WORKING XTREME
SOFTSHELL JAKKE**

- // Vindtæt, vandafvisende og åndbar
- // Justerbar i nedre kant
- // Justering i ærmer med gribebånd
- // Aftagelig hætte
- // Indvendig lomme med lynlås



Size XS - 5XL

Size L back length: 73 cm / 28.5 in
Water column main fabric: > 5.000 mm H₂O
Breathability: > 3.000 g/m²/24h96% POLYESTER, 4% SPANDEX. FLEECE
BACKING. 320 G/M²

ART. 117300

EN WORKING XTREME SOFTSHELL JACKET

- // Windproof, water repellent and breathable
- // Reversed 2-way YKK zipper
- // Detachable hood with string and hook & loop
- // Sleeves with hook & loop adjustment and hand protection

D WORKING XTREME SOFTSHELLJACKE

- // Winddicht, wasserabweisend und atmungsaktiv
- // 2-Wege YKK-Reißverschluss
- // Abnehmbare Kapuze m. Kordel und Klettverstellung
- // Verstellbar Ärmel mit Klettverschluss und Handschutz

DK WORKING XTREME SOFTSHELL JAKKE

- // Vindtæt, vandafvisende og åndbar
- // Reversed 2-vejs YKK-lynlås i front
- // Justerbar aftagelig hætte med gribebånd på bagsiden
- // Justerbare ærmer med gribebånd og håndbeskyttelse



Detachable sleeves



Working Xtreme
BY ELKA

WATER COLUMN
8.000
MM

Size XS - 5XL

Size L back length: 78 cm / 30.5 in
Water column main fabric: > 8.000 mm H₂O
Breathability: > 5.000 g/m²/24h



010	051	052	146
BLACK	NAVY/ BLACK	GREEN/ BLACK	RED/ BLACK

147
ROYAL BLUE/BLACK

100% POLYESTER. TWILL. FLEECE BACKING. 320 G/M²



ART. 117200

EN WORKING XTREME SOFTSHELL JACKET

- // Windproof, water repellent and breathable
- // YKK main zipper
- // Storm flap with hook & loop
- // Adjustable sleeves with hook & loop
- // Segmented black LOXY® reflective tape

D WORKING XTREME SOFTSHELLJACKE

- // Winddicht, wasserabweisend und atmungsaktiv
- // YKK Frontreißverschluss
- // Wetterschutzleiste mit Klett
- // Ärmel verstellbar mit Klett
- // Segmentierte schwarze LOXY®-Reflektoren

DK WORKING XTREME SOFTSHELL JAKKE

- // Vindtæt, vandafvisende og åndbar
- // YKK-lynlås i front
- // Vindfang med gribebånd
- // Justering i ærmer med gribebånd
- // Segmenterede sorte LOXY®-reflekser



Working Xtreme
BY ELKA

WATER COLUMN
8.000
MM

Size XS - 5XL

Size L back length: 78 cm / 30.5 in
Water column main fabric: > 8.000 mm H₂O
Breathability: > 5.000 g/m²/24h

010
BLACK

96% POLYESTER. 4% SPANDEX. 100D PLAIN. FLEECE BACKING. 320 G/M²



ILLUMINATED REFLECTIVE TAPE.





SecureTech Multinorm

EN

In line with growing demands from the industrial markets, ELKA has developed a series of high quality and certified work rainwear for optimum safety in the most exposed work areas.

The products are available in the flexible and durable PU/ polyester material which combines a high tear strength with a natural elasticity and comfort. Furthermore the **SecureTech Multinorm** collection includes products made in Oxford polyester for a 100% wind-, waterproof and breathable fabric.

The products live up to a series of EN standards, all of which place high demands on the design and performance of the protective clothing. All ELKA products are certified at EU approved test institutes.

D

Entsprechend den wachsenden Anforderungen der Industriemärkte hat ELKA eine Reihe von hochwertigen und zertifizierte Arbeitsbekleidung für optimale Sicherheit in gefährdeten Arbeitsbereichen entwickelt.

Die Produkte sind aus unserem flexiblen sowie robusten PU/ Polyestergewebe, welches eine hohe Reißfestigkeit mit natürlicher Elastizität und Komfort verbindet. Darüber hinaus umfasst die **SecureTech Multinorm**-Kollektion Produkte aus Oxford-Polyester aus einem 100% wind-, wasserdichtes sowie atmungsaktives Gewebe.

Die Produkte erfüllen eine Reihe von EN-Normen, die eine hohe Anforderung an das Design und Leistung der Schutzkleidung stellen. Alle ELKA Artikel sind von EU-anerkannte Prüfinstitute zertifiziert.

DK

I tråd med stigende krav fra de industrielle markeder, har ELKA udviklet en serie af højkvalitets- og certificeret arbejdsregntøj for optimal sikkerhed på de mest udsatte arbejdsområder.

Produkterne fås i det fleksible og holdbare PU/polyester materiale, der kombinerer en høj rivstyrke med en naturlig elasticitet og komfort. **SecureTech Multinorm** kollektionen inkluderer også produkter fremstillet i Oxford polyester, som er 100% vind-, vandtæt og åndbart.

Produkterne lever op til en række EN-standarder, som alle stiller høje krav til sikkerhedsbeklædningens design og ydeevne. Alle ELKA produkter er certificeret på EU-godkendte test-institutter.

ART. 086060R

SecureTech
Multinorm

WATER COLUMN
8.000
MM



Size S - 5XL

Size L back length: 90 cm / 35.5 in

Water column main fabric: > 8.000 mm H₂O

Breathability: > 5.000 g/m²/24h



031

FL. ORANGE/ FL. YELLOW/
NAVY NAVY



041

98% POLYESTER, 2% CARBON, BACKING:
60% PROTEX, 40% COTTON, 340 G/M²



READY FOR ZIP-IN JACKET
ART. 156060 / ART. 166060.

**EN SECURETECH MULTINORM
ELECTRIC ARC JACKET**

- // Taped seams
- // Reflective tape
- // Inside smartphone pocket
- // Two-way zipper
- // 2 chest loops
- // 3 pockets with hook & loop
- // Double storm flap with hook & loop
- // ID pocket
- // Detachable and adjustable hood

**D SECURETECH MULTINORM
STÖRLICHTBOGEN PARKA**

- // Nähte getaped
- // Reflexstreifen
- // Smartphone Tasche
- // 2-Wege Reißverschluss
- // 2 Brusttaschen
- // 3 Taschen mit Klett
- // Doppelte Wetterschutzleiste mit Klett
- // ID Tasche
- // Abnehmbare Kapuze

**DK SECURETECH MULTINORM
LYSBUE ARC JAKKE**

- // Tapede sømme
- // Reflekser
- // Indvendig smartphone lomme
- // 2-vejs lynlås
- // 2 bryst løkker
- // 3 lommer med gribebånd
- // Dobbelt vindfang med gribebånd
- // ID-lomme
- // Aftagelig og justerbar hætte



Windproof
Waterproof
Breathable



Zip-in
Zip-out

ART. 082460R



SecureTech
Multinorm

WATER COLUMN
8.000
MM

Size S - 5XL

Size L inner leg length: 82 cm / 32 in
Water column main fabric: > 8.000 mm H₂O
Breathability: > 5.000 g/m²/24h

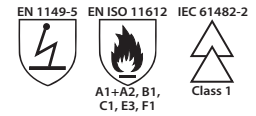
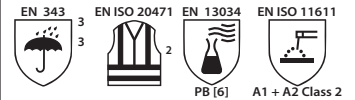

031

FL. ORANGE/ FL. YELLOW/
NAVY NAVY



041

98% POLYESTER, 2% CARBON, BACKING:
60% PROTEX, 40% COTTON, 340 G/M²



**EN SECURETECH MULTINORM
ELECTRIC ARC WAIST
TROUSERS**

- // Taped seams
- // Elastic in waist
- // Detachable and adjustable suspenders
- // ID-pocket
- // Leg zipper with storm flap
- // Reflective tape

**D SECURETECH MULTINORM
STÖRLICHTBOGEN
BUNDHOSE**

- // Nähte getaped
- // Elastik am Taille
- // Abnehmbare Träger
- // ID-Tasche
- // Reißverschluss m. Schutzleiste am Bein
- // Reflexstreifen

**DK SECURETECH MULTINORM
LYSBUE TALJEBUKSER**

- // Tapede sømme
- // Elastik i talje
- // Aftagelige og justerbare seler
- // ID-lomme
- // Lynlås med vindfang og gribebånd i ben
- // Refleksbånd



Windproof
Waterproof
Breathable



Zipper in
legs

ART. 086060

SecureTech
Multinorm

WATER COLUMN
8.000
MM



Size XS - 5XL

Size L back length: 90 cm / 35.5 in

Water column main fabric: > 8.000 mm H₂O

Breathability: > 5.000 g/m²/24h



EN ISO 11612 IEC 61482-2



007
NAVY

98% POLYESTER, 2% CARBON, BACKING:
60% PROTEX, 40% COTTON, 340 G/M²



READY FOR ZIP-IN JACKET
ART. 156060 / ART. 166060.

**EN SECURETECH MULTINORM
ELECTRIC ARC JACKET**

- // Taped seams
- // Reflective tape
- // Inside smartphone pocket
- // Two-way zipper
- // 2 chest loops
- // 3 pockets with hook & loop
- // Double storm flap with hook & loop
- // ID pocket
- // Detachable and adjustable hood

**D SECURETECH MULTINORM
STÖRLICHTBOGEN JACKE**

- // Nähte getaped
- // Reflexstreifen
- // Smartphone tasche
- // 2-Wege Reißverschluss
- // 2 Brusttaschen
- // 3 Taschen mit Klett
- // Doppelte Wetterschutzleiste mit Klett
- // ID Tasche
- // Abnehmbare Kapuze

**DK SECURETECH MULTINORM
LYSBUE ARC JAKKE**

- // Tapede sømme
- // Reflekser
- // Indvendig smartphone lomme
- // 2-vejs lynlås
- // 2 bryst løkker
- // 3 lommer med gribebånd
- // Dobbelt vindfang med gribebånd
- // ID-lomme
- // Aftagelig og justerbar hætte



Windproof
Waterproof
Breathable



Zip-in
Zip-out

ART. 156060

EN SECURETECH MULTINORM ANTI-FLAME ZIP-IN FLEECEJACKET

- Antistatic
- 2 side pockets
- Extra back length
- Inserted through elastic loops in sleeves and neck and zipper in front

D SECURETECH MULTINORM ZIPP-IN FLEECEJACKE MIT FLAMMSCHUTZ

- Antistatisch
- 2 Fronttaschen
- Extra Rückenlänge
- Wird eingebaut durch Elastikschlaufen am Ärmel und am Nacken sowie Reißverschluss am front

DK SECURETECH MULTINORM ANTI-FLAME ZIP-IN FLEECEJAKKE

- Antistatisk
- 2 sidelommer
- Ekstra ryglængde
- Indsættes via elastikloops i ærmer og nakke samt lynlås i front



Zip-in
Zip-out



SecureTech
Multinorm

<p>Size XS - 5XL Size L back length: 77 cm / 30 in</p>
<p>EN 1149-5 EN ISO 11612 A1+A2, B1, C1, F2</p>
<p>007 NAVY</p>
<p>100% MODACRYLIC. FLEECE FABRIC. 330 G/M²</p>
<p></p>

ZIP-IN JACKET FOR SHELL JACKETS
ART. 086060 / ART. 086060R.

ART. 166060

EN SECURETECH MULTINORM ANTI-FLAME ZIP-IN JACKET

- Inner pocket
- 2 side pockets
- Extra back length
- Inserted through elastic loops in sleeves and neck and zipper in front

D SECURETECH MULTINORM ZIPP-IN JACKE MIT FLAMMSCHUTZ

- Innentaschen
- 2 Fronttaschen
- Extra Rückenlänge
- Wird eingebaut durch Elastikschlaufen am Ärmel und am Nacken sowie Reißverschluss am front

DK SECURETECH MULTINORM ANTI-FLAME ZIP-IN JAKKE

- Inderlomme
- 2 sidelommer
- Ekstra ryglængde
- Indsættes via elastikloops i ærmer og nakke samt lynlås i front



Zip-in
Zip-out



SecureTech
Multinorm

<p>Size XS - 5XL Size L back length: 80 cm / 31.5 in</p>
<p>EN ISO 11612 A1+A2, B1, C1, F2</p>
<p>010 BLACK</p>
<p>100% FR COTTON SHELL MATERIAL 210 G/M². 100% POLYESTER PADDING 80 G/M²</p>
<p></p>

ZIP-IN JACKET FOR SHELL JACKETS
ART. 086060 / ART. 086060R.

ART. 086151R

SecureTech
Multinorm

WATER COLUMN
8.000
MM



Size S - 5XL

Size L back length: 86 cm / 34 in

Water column main fabric: > 8.000 mm H₂O

Breathability: > 5.000 g/m²/24h



031 FL. ORANGE/
NAVY

041 FL. YELLOW/
NAVY

98% POLYESTER, 2% CARBON, 300D
OXFORD, 240 G/M²



READY FOR ZIP-IN JACKET
ART. 166151.

EN SECURETECH MULTINORM SHELL JACKET

- // Taped seams
- // Reflective tape above shoulder
- // Detachable hood
- // Two-way zipper
- // 2 phone pockets
- // 3 pockets with hook & loop
- // Double storm flap with hook & loop and buttons
- // 3 inside pockets
- // ID pocket
- // Adjustable wrist and lower hem
- // Print access

D SECURETECH MULTINORM PARKA OHNE FUTTER

- // Nähte getaped
- // Reflex über den Schultern
- // Abnehmbare Kapuze
- // 2-Wege Reißverschluss
- // 2 Smartphone-Tasche
- // 3 Taschen mit Klett
- // Doppelte Wetterschutzleiste mit Klett und Knöpfen
- // 3 Innentaschen
- // ID Tasche
- // Verstellbar am Ärmel und Kordelzug an untere Kante
- // Zugang für Veredelung

DK SECURETECH MULTINORM SKALJAKKE

- // Tapede sømme
- // Refleks over skuldre
- // Aftagelig hætte
- // 2-vejs lynlås
- // 2 mobilommer
- // 3 lommer med gribebånd
- // Dobbelt vindfang med gribebånd og knapper
- // 3 indvendige lommer
- // ID-lomme
- // Justerbar ved håndled samt snøretræk i nedre kant
- // Mulighed for rygprint



Windproof
Waterproof
Breathable



Zip-in
Zip-out

ART. 089951R

EN SECURETECH MULTINORM BIB & BRACE

- // Taped seams
- // Adjustable suspenders with Fix-lock
- // Elastic in waist
- // Zipper with inside wind catch on leg
- // ID pocket

D SECURETECH MULTINORM LATZHOSE

- // Nähte getaped
- // Träger mit Fix-Lock
- // Elastik am Taille
- // Reißverschluss und Klett am Bein
- // ID-Tasche

DK SECURETECH MULTINORM OVERALL

- // Tapede sømme
- // Justerbare seler med Fix-lock
- // Elastik i talje
- // Lynlås med vindfang og gribebånd i ben
- // ID-lomme



Windproof
Waterproof
Breathable



Zipper in
legs



SecureTech
Multinorm

WATER COLUMN
8.000
MM

Size S - 5XL

Size L inner leg length: 82 cm / 32 in
Water column main fabric: > 8.000 mm H₂O
Breathability: > 5.000 g/m²/24h

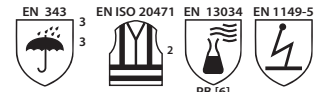

EN ISO 14116



Index 1



031

FL. ORANGE/
NAVY



041

FL. YELLOW/
NAVY

98% POLYESTER, 2% CARBON, 300D
OXFORD, 240 G/M²



MAX. 25X

ART. 166151

EN SECURETECH MULTINORM ANTIFLAME ZIP-IN JACKET

- // Inserted through elastic loops in sleeves and neck and zipper in front
- // Elastic in cuffs
- // Inner pocket
- // Extra back length

D SECURETECH MULTINORM ZIPP-IN JACKE MIT FLAMMSCHUTZ

- // Wird eingebaut durch Elastikschlaufen am Ärmel und am Nacken sowie Reißverschluss am front
- // Elastik am Ärmel
- // Innentaschen
- // Extra Rückenlänge

DK SECURETECH MULTINORM ANTIFLAME ZIP-IN JAKKE

- // Indsættes via elastik loops i ærmer og nakke samt lynlås i front
- // Elastik i ærmer
- // Inderlomme
- // Ekstra ryglængde



SecureTech
Multinorm

Size S - 5XL

Size L back length: 80 cm / 31.5 in

EN ISO 14116



Index 3



010

BLACK

100% FR COTTON SHELL MATERIAL
210 G/M². 100% POLYESTER PADDING
80 G/M²



ZIP-IN JACKET FOR SHELL
JACKET
ART. 086151R.



Zip-in
Zip-out

ART. 086150R

SecureTech
Multinorm

WATER COLUMN
8.000
MM

EN SECURETECH MULTINORM JACKET

- // Taped seams
- // Zip out Antiflame inner jacket
- // 2-way zipper
- // Double storm flap with hook & loop and buttons
- // Print access

D SECURETECH MULTINORM PARKA

- // Nähte getaped
- // Herausnehmbare Innenjacke mit Flammschutz
- // 2-Wege Reißverschluss
- // Doppelte Wetterschutzleiste mit Klett und Knöpfen
- // Zugang für Veredelung

DK SECURETECH MULTINORM JAKKE

- // Tapede sømme
- // Aftagelig antiflame inderjakke
- // 2-vejs lynlås
- // Dobbelt vindfang med gribebånd og knapper
- // Mulighed for rygprint



Windproof
Waterproof
Breathable



Winter

Size S - 5XL
Size L back length: 86 cm / 34 in
Water column main fabric: > 8.000 mm H₂O
Breathability: > 5.000 g/m²/24h

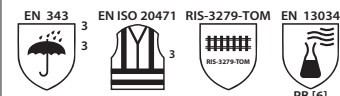

031 FL. ORANGE/
NAVY

041 FL. YELLOW/
NAVY

98% POLYESTER, 2% CARBON, 300D
OXFORD, 240 G/M²



3-IN-1 JACKET.

ART. 082450R

SecureTech
Multinorm

WATER COLUMN
8.000
MM

EN SECURETECH MULTINORM WAIST TROUSERS

- // Taped seams
- // Hook & loop adjustment in waist
- // Cordura® reinforcement and kneepad pockets
- // Tool pocket
- // Hammer loop

D SECURETECH MULTINORM BUNDHOSE

- // Nähte getaped
- // Klett-Verstellung im Bund
- // Cordura® Knietasche und Verstärkung
- // Zollstocktasche
- // Hammerschlaufe

DK SECURETECH MULTINORM TALJEBUKSER

- // Tapede sømme
- // Taljejustering med gribebånd
- // Cordura® knælomme og forstærkning
- // Tommestok-lomme
- // Hammerstrop



Windproof
Waterproof
Breathable



Zipper in
legs



Pockets for
knee pads

Size S - 5XL
Size L inner leg length: 84 cm / 33 in
Water column main fabric: > 8.000 mm H₂O
Breathability: > 5.000 g/m²/24h



031 FL. ORANGE/
NAVY

041 FL. YELLOW/
NAVY

98% POLYESTER, 2% CARBON, 300D
OXFORD, 240 G/M²



ART. **026350**

EN SECURETECH MULTINORM PU JACKET

- // Reflective tape
- // Hidden / adjustable hood
- // 2 pockets with flaps
- // Zipper and storm flap with press buttons
- // Hook & loop in sleeve

D SECURETECH MULTINORM PU JACKE

- // Reflex
- // Versteckte Kapuze mit Kordelzug
- // 2 Taschen mit Patte
- // Reißverschluss und Wetterschutzleiste mit Druckknöpfen
- // Klett am Ärmel

DK SECURETECH MULTINORM PU JAKKE

- // Refleks
- // Skjult hætte med snøretræk
- // 2 lommer med klap
- // Lynlås og vindfang med trykknapper
- // Lukkes i ærme med gribebånd



SecureTech
Multinorm

WATER COLUMN
5.000
MM

Size XS - 5XL

Size L back length: 82 cm / 32 in
Water column main fabric: > 5.000 mm H₂O

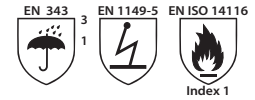

007
NAVY

100% POLYESTER, COATING:
POLYURETHANE 200 G/M²



Reinforcement
under arm

ART. **022450**

EN SECURETECH MULTINORM PU WAIST TROUSERS

- // Zipper and wind catch in leg
- // 2 pocket openings
- // Reinforced welding on pressure points
- // Cargo pocket
- // Tool pocket

D SECURETECH MULTINORM PU BUNDSHOSE

- // Reißverschluss am Bein und Windfang
- // Extra Verschweißung im Schritt
- // 2 Tascheneingriffe
- // Cargotasche
- // Zollstocktasche

DK SECURETECH MULTINORM PU TALJEBUKS

- // Lynlås og vindfang i ben
- // Forstærket svejsning i skridtet
- // 2 lommeindgange
- // Cargolomme
- // Tømmestoklomme



SecureTech
Multinorm

WATER COLUMN
5.000
MM

Size XS - 5XL

Size L inner leg length: 82 cm / 32 in
Water column main fabric: > 5.000 mm H₂O



007
NAVY

100% POLYESTER, COATING:
POLYURETHANE 200 G/M²



Zipper in
legs



Reinforcement
in crotch

ART. 026350R

SecureTech
Multinorm

WATER COLUMN
5.000
MM

**EN SECURETECH MULTINORM
PU JACKET**

- // Reflective tape above shoulder
- // Hidden / adjustable hood
- // 2 pockets with flaps
- // Zipper and storm flap with press buttons
- // Sleeves with hook & loop adjustment

**D SECURETECH MULTINORM
PU JACKE**

- // Reflex über den Schultern
- // Versteckte Kapuze mit Kordelzug
- // 2 Taschen mit Patte
- // Reißverschluss und Wetterschutzleiste mit Druckknöpfen
- // Klett am Ärmel

**DK SECURETECH MULTINORM
PU JAKKE**

- // Refleks over skuldre
- // Skjult hætte med snøretræk
- // 2 lommer med klap
- // Lynlås og vindfang med trykknapper
- // Justerbare ærmer med gribebånd



Size XS - 5XL
Size L back length: 82 cm / 32 in
Water column main fabric: > 5.000 mm H₂O

EN 343 3 1 EN ISO 20471 3 EN 1149-5 EN ISO 14116
Index 1

030 040
FL. FL.
ORANGE YELLOW

100% POLYESTER, COATING:
POLYURETHANE 200 G/M²



Reinforcement
under arm

ART. 028850R

SecureTech
Multinorm

WATER COLUMN
5.000
MM

**EN SECURETECH MULTINORM
PU BIB & BRACE**

- // Reflective tape
- // Press buttons in leg
- // Adjustable suspenders with Fix-lock
- // Reinforced welding on pressure points

**D SECURETECH MULTINORM
PU LATZHOSE**

- // Reflexstreifen
- // Druckknopf am Bein
- // Verstellbare Träger mit Fix-lock
- // Verstärkung im Schritt

**DK SECURETECH MULTINORM
PU OVERALL**

- // Refleksstriber
- // Trykknop i ben
- // Justerbare seler med Fix-lock spænde
- // Forstærket svejsning i skridtet



Size XS - 5XL
Size L inner leg length: 72 cm / 28.5 in
Water column main fabric: > 5.000 mm H₂O

EN 343 3 1 EN ISO 20471 2 EN 1149-5 EN ISO 14116
Index 1

030 040
FL. FL.
ORANGE YELLOW

100% POLYESTER, COATING:
POLYURETHANE 200 G/M²



Reinforcement
in crotch

ART. **022450R**

**EN SECURETECH MULTINORM
PU WAIST TROUSERS**

- // Zipper and wind catch in leg
- // 2 pocket openings
- // Cargo pocket
- // Tool pocket
- // Reinforced welding on pressure points

**D SECURETECH MULTINORM
PU BUNDHOSE**

- // Reißverschluss am Bein & Windfang
- // 2 Tascheneingriffe
- // Extra Verschweißung im Schritt
- // Cargotasche
- // Zollstocktasche

**DK SECURETECH MULTINORM
PU TALJEBUKS**

- // 2 lommeindgange
- // Lynlås og vindfang i ben
- // Forstærket svejsning i skridtet
- // Cargolomme
- // Tømmestoklomme



Zipper in legs



Reinforcement in crotch



SecureTech
Multinorm

WATER COLUMN
5.000
MM

Size XS - 5XL

Size L inner leg length: 82 cm / 32 in
Water column main fabric: > 5.000 mm H₂O

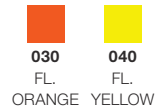

100% POLYESTER, COATING:
POLYURETHANE 200 G/M²



ART. **022451R**

**EN SECURETECH MULTINORM
PU WAIST TROUSERS**

- // Reinforced welding on pressure points
- // Elastic in waist
- // Press buttons in legs

**D SECURETECH MULTINORM
PU BUNDHOSE**

- // Extra Verschweißung im Schritt
- // Elastik im Bund
- // Druckknöpfe am Bein

**DK SECURETECH MULTINORM
PU TALJEBUKS**

- // Forstærket svejsning i skridtet
- // Elastik i talje
- // Trykknop i ben



SecureTech
Multinorm

WATER COLUMN
5.000
MM

Size XS - 5XL

Size L inner leg length: 82 cm / 32 in
Water column main fabric: > 5.000 mm H₂O

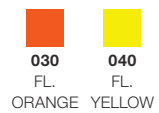

100% POLYESTER, COATING:
POLYURETHANE 200 G/M²



Reinforcement in crotch





DryZone

BY ELKA

DryZone
D-Lux
BY ELKA

DryZone
Visible
BY ELKA

EN

Dry Zone is the result of many years of experience and product development within PU rainwear. The collection covers a wide range of durable, lightweight and flexible PU / polyester products, ranging from basic rainwear to products with carefully selected details. The Dry Zone collections also have a wide selection with high visibility, all of which are EN ISO 20471 certified.

All products in the Dry Zone collections have high stretchability, which optimizes comfort and freedom of movement.

D

Dry Zone ist das Ergebnis langjähriger Erfahrung und Produktentwicklung im Bereich PU-Regenbekleidung. Die Kollektion umfasst eine breite Palette an strapazierfähigen, leichten und flexiblen PU/Polyester-Produkten, die von einfacher Regenbekleidung bis hin zu Produkten mit sorgfältig ausgewählten Details reichen. Auch die Dry Zone-Kollektionen bieten eine große Auswahl mit hoher Sichtbarkeit, die alle nach EN ISO 20471 zertifiziert sind.

Alle Produkte der Dry Zone-Kollektionen verfügen über eine hohe Dehnbarkeit, die den Komfort und die Bewegungsfreiheit optimiert.

DK

Dry Zone er resultatet af mange års erfaring og produktudvikling indenfor PU-regntøj. Kollektionen dækker en bred vifte af holdbare, lette og fleksible PU/polyester produkter, der spænder fra basis regnsæt til produkter med nøje udvalgte detaljer. I Dry Zone kollektionerne findes også et bredt udvalg med høj synlighed, som alle er EN ISO 20471 certificerede. Alle produkter i Dry Zone kollektionerne har høj strækbarhed, som optimerer komfort og bevægelsesfrihed.

ART. 026300

DryZone
BY ELKA

WATER COLUMN
8.000
MM

EN DRY ZONE PU JACKET

- // Hidden / adjustable hood
- // Press buttons in sleeve
- // Zipper and storm flap with press buttons
- // Reinforced welding on pressure points
- // 2 pockets with flaps

D DRY ZONE PU JACKE

- // Versteckte Kapuze mit Kordelzug
- // Druckknopf am Ärmel
- // Reißverschluss & Wetterschutzleiste mit Druckknöpfen
- // Extra Verschweißung an anfälligen Stellen
- // 2 Taschen mit Patte

DK DRY ZONE PU JAKKE

- // Skjult hætte med snøetræk
- // Trykknop i ærmer
- // Lynlås og vindfang med trykknapper
- // Forstærkede svejsninger på udsatte steder
- // 2 lommer med klap



Size XS - 5XL
Size L back length: 76 cm / 30 in
Water column main fabric: > 8.000 mm H₂O

EN 343 3 1

001 006 007 008 010
OLIVE ORANGE NAVY YELLOW BLACK

100% POLYESTER, COATING:
POLYURETHANE 190 G/M²



Reinforcement under arm

ART. 022400

DryZone
BY ELKA

WATER COLUMN
8.000
MM

EN DRY ZONE PU WAIST TROUSERS

- // Press buttons in leg
- // Reinforced welded seams on pressure points
- // Elasticated waist

D DRY ZONE PU BUNDBHOSE

- // Druckknopf am Bein
- // Extra Verschweißung im Schritt
- // Taillenelastik

DK DRY ZONE PU TALJEBUKSER

- // Trykknop i ben
- // Forstærket svejsning i skridtet
- // Elastik i taljen



Size XS - 5XL
Size L inner leg length: 82 cm / 32 in
Water column main fabric: > 8.000 mm H₂O

EN 343 3 1

001 006 007 008 010
OLIVE ORANGE NAVY YELLOW BLACK

100% POLYESTER, COATING:
POLYURETHANE 190 G/M²



Reinforcement in crotch

ART. 029900

EN DRY ZONE PU BIB & BRACE

- // Press buttons in leg
- // Adjustable suspenders with Fix-lock
- // Reinforced welded seams on pressure points

D DRY ZONE PU LATZHOSE

- // Druckknopf am Bein
- // Verstellbare Träger mit Fix-lock
- // Extra Verschweißung im Schritt

DK DRY ZONE PU OVERALL

- // Trykknop i ben
- // Justerbare seler med Fix-lock spænde
- // Forstærket svejsning i skridtet



DryZone BY ELKA

WATER COLUMN
8.000
MM

Size XS - 5XL
Size L inner leg length: 72 cm / 28.5 in
Water column main fabric: > 8.000 mm H₂O

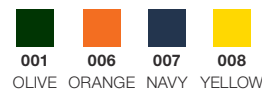

100% POLYESTER, COATING:
POLYURETHANE 190 G/M²



Reinforcement
in crotch

ART. 0163124

EN DRY ZONE PU JACKET AND WAIST TROUSERS

- // Zipper and storm flap with press buttons
- // Hidden / adjustable hood
- // Reinforced welded seams on pressure points
- // Press buttons in leg
- // Elasticated waist

D DRY ZONE PU JACKE UND BUNDHOSE

- // Reißverschluss und Wetterschutzleiste mit Druckknöpfen
- // Versteckte Kapuze mit Kordelzug
- // Extra Verschweißungen an anfällige Stellen
- // Druckknopf am Bein
- // Taillenelastik

DK DRY ZONE PU JAKKE OG TALJEBUKSER

- // Lynlås og stormflap med trykknapper
- // Skjult hætte med snøretræk
- // Forstærkede svejsninger på udsatte steder
- // Trykknop i ben
- // Elastik i taljen



DryZone BY ELKA

WATER COLUMN
8.000
MM

Size XS - 5XL
Size L back length: 76 cm / 30 in
Size L inner leg length: 79 cm / 31 in
Water column main fabric: > 8.000 mm H₂O



100% POLYESTER, COATING:
POLYURETHANE 190 G/M²



Reinforcement
under arm



Reinforcement
in crotch

ART. 028003

DryZone
BY ELKA

WATER COLUMN
8.000
MM

EN DRY ZONE PU COVERALL

- // Hidden/adjustable hood
- // Wind catch and hook & loop in sleeve
- // Zipper & storm flap
- // Press buttons in leg
- // Reinforced welded seams on pressure points

D DRY ZONE PU OVERALL

- // Versteckte Kapuze mit Kordelzug
- // Ärmelwindfang mit Elastik und Klett
- // Extra Verschweißung im Schritt
- // Druckknopf am Bein
- // Reißverschluss und doppelte Wetterschutzleiste

DK DRY ZONE PU HELDRAGT

- // Skjult hætte med snøretræk
- // Ærmevindfang med elastik og gribebånd
- // Lynlås og dobbelt vindfang
- // Trykknop i ben
- // Forstærket svejsning i skridtet



<p>Size XS - 5XL Size L inner leg length: 76 cm / 30 in Water column main fabric: > 8.000 mm H₂O</p>									
<table border="0"> <tr> <td></td> <td></td> <td></td> </tr> <tr> <td>001</td> <td>006</td> <td>007</td> </tr> <tr> <td>OLIVE</td> <td>ORANGE</td> <td>NAVY</td> </tr> </table>				001	006	007	OLIVE	ORANGE	NAVY
001	006	007							
OLIVE	ORANGE	NAVY							
<p>100% POLYESTER, COATING: POLYURETHANE 190 G/M²</p>									



Reinforcement under arm



Reinforcement in crotch

ART. 306600

ELEMENTS
BY ELKA

WATER COLUMN
8.000
MM

EN JACKET

- // Zipper
- // Storm flap with press buttons
- // Adjustable hood
- // Press buttons in sleeves
- // Reinforced welding on pressure points

D JACKE

- // Reißverschluss
- // Wetterschutzleiste mit Druckknöpfen
- // Kapuze mit Kordelzug
- // Druckknopf am Ärmel
- // Extra Verschweißung an anfälligen Stellen

DK JAKKE

- // Lynlås
- // Vindfang med trykknapper
- // Hætte med snøretræk
- // Trykknop i ærmer
- // Forstærkede svejsninger på udsatte steder



<p>Size XS - 5XL Size L back length: 76 cm / 30 in Water column main fabric: > 8.000 mm H₂O</p>									
<table border="0"> <tr> <td></td> <td></td> <td></td> </tr> <tr> <td>001</td> <td>008</td> <td>010</td> </tr> <tr> <td>OLIVE</td> <td>YELLOW</td> <td>BLACK</td> </tr> </table>				001	008	010	OLIVE	YELLOW	BLACK
001	008	010							
OLIVE	YELLOW	BLACK							
<p>100% POLYESTER, COATING: PU/PVC 320 G/M²</p>									

ART. 302400

EN WAIST TROUSERS

- // Press buttons in leg
- // Reinforced welded seams on pressure points
- // Elasticated waist with drawstring

D BUNDHOSE

- // Druckknopf am Bein
- // Extra Verschweißung im Schritt
- // Taillanelastik mit Kordelzug

DK TALJEBUKS

- // Trykknop i ben
- // Forstærket svejsning i skridtet
- // Elastik i talje samt snoretræk



ELEMENTS
BY ELKA

WATER COLUMN
8.000
MM

Size XS - 5XL

Size L inner leg length: 82 cm / 32 in
Water column main fabric: > 8.000 mm H₂O



100% POLYESTER, COATING: PU/PVC
320 G/M²



ART. 309900

EN BIB & BRACE

- // Press buttons in leg
- // Press buttons in chestpiece
- // Adjustable suspenders with Fix-lock
- // Reinforced welded seams on pressure points

D LATZHOSE

- // Druckknopf am Bein
- // Druckknopf im Seitenteil
- // Verstellbare Träger mit Fix-lock
- // Extra Verschweißung im Schritt

DK OVERALL

- // Trykknop i ben
- // Trykknop i sidestykke
- // Justerbare seler med Fix-lock spænde
- // Forstærket svejsning i skridtet



ELEMENTS
BY ELKA

WATER COLUMN
8.000
MM

Size XS - 5XL

Size L inner leg length: 72 cm / 28.5 in
Water column main fabric: > 8.000 mm H₂O

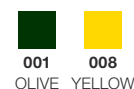

100% POLYESTER, COATING: PU/PVC
320 G/M²



ART. 026302

DryZone
D-Lux
BY ELKA

WATER COLUMN
8.000
MM

EN DRY ZONE D-LUX JACKET

- // Fleece backing in neck
- // Zipper and storm flap with press buttons
- // Hidden / adjustable hood
- // Air vents in back
- // Reflective details on sleeves and chest

D DRY ZONE D-LUX JACKE

- // Fleecefutter am Kragen
- // Reißverschluss und doppelte Wetterschutzleiste mit Druckknöpfen
- // Abnehmbare Kapuze m. Kordelzug
- // Rückenentlüftung
- // Reflexapplikationen am Ärmel und am Brust

DK DRY ZONE D-LUX JAKKE

- // Fleece backing i krave
- // Lynlås og dobbelt vindfang med trykknapper
- // Skjult aftagelig hætte med snøretræk
- // Rygdudluftning
- // Refleksdetaljer på ærmer og bryst



<p>Size XS - 5XL Size L back length: 80 cm / 31.5 in Water column main fabric: > 8.000 mm H₂O</p>
<p>010 BLACK</p>
<p>100% POLYESTER, COATING: POLYURETHANE 190 G/M²</p>



Reinforcement under arm

ART. 022402

DryZone
D-Lux
BY ELKA

WATER COLUMN
8.000
MM

EN DRY ZONE D-LUX WAIST TROUSERS

- // Reflective details
- // Elasticated waist with draw strings
- // Zipper with inside wind catch on leg
- // Press buttons in leg

D DRY ZONE D-LUX BUNDHOSE

- // Elastik und Kordelzug im Bund
- // Reflexapplikationen am Bein
- // Reißverschluss mit Windfang am Bein
- // Druckknopf am Bein

DK DRY ZONE D-LUX TALJEBUKSER

- // Elastik og snøretræk i talje
- // Refleksdetaljer på ben
- // Lynlås med vindfang i ben
- // Trykknop i ben



<p>Size XS - 5XL Size L inner leg length: 82 cm / 32 in Water column main fabric: > 8.000 mm H₂O</p>
<p>010 BLACK</p>
<p>100% POLYESTER, COATING: POLYURETHANE 190 G/M²</p>



Zipper in legs



Reinforcement in crotch

ART. 026301

EN DRY ZONE D-LUX JACKET

- // Reflective stripes
- // 2-way zipper with storm flap
- // Hidden / adjustable hood with draw strings
- // Elasticised sleeve and hook & loop adjustment
- // 2 pockets with flap

D DRY ZONE D-LUX JACKE

- // Reflexstreifen am Rücken und Brust
- // 2-Wege Reißverschluss und Wetterschutzleiste
- // Versteckte Kapuze mit Kordelzug
- // Elastik und Klett am Ärmel
- // 2 Taschen mit Patte

DK DRY ZONE D-LUX JAKKE

- // Refleksstriber over bryst og ryg
- // 2-vejs lynlås med vindfang i front
- // Skjult hætte med snøre
- // Elastik og gribebånd på ærme
- // 2 lommer med klap



Dryzone
D-Lux
BY ELKA

WATER COLUMN
8.000
MM

Size XS - 5XL
Size L back length: 89 cm / 35 in
Water column main fabric: > 8.000 mm H₂O



100% POLYESTER, COATING:
POLYURETHANE 190 G/M²



EXTRA LENGTH.



Reinforcement
under arm

ART. 022401

EN DRY ZONE D-LUX WAIST TROUSERS

- // Elasticised waist
- // 2 pocket openings inside seam
- // Tool pocket on leg
- // Zipper with wind catch on leg
- // Reflective tape on leg

D DRY ZONE D-LUX BUNDBHOSE

- // Elastik im Bund
- // 2 Taschen-Öffnungen in der Seitennaht
- // Zollstocktasche am rechten Bein
- // Reißverschluss mit Wingfang am Bein
- // Reflex am Bein

DK DRY ZONE D-LUX TALJEBUKSER

- // Elastik i talje
- // 2 lommeåbninger i sidesøm
- // Tømmestok-lomme på højre ben
- // Lynlås med vindfang i ben
- // Refleks på ben



Dryzone
D-Lux
BY ELKA

WATER COLUMN
8.000
MM

Size XS - 5XL
Size L inner leg length: 82 cm / 32 in
Water column main fabric: > 8.000 mm H₂O



100% POLYESTER, COATING:
POLYURETHANE 190 G/M²



Zipper in
legs



Reinforcement
in crotch

ART. 026300R

DryZone
Visible
BY ELKA

WATER COLUMN
8.000
MM

EN DRY ZONE VISIBLE JACKET

- // 3M Reflective tape
- // Zipper and storm flap with press buttons
- // Hidden/ adjustable hood
- // Elasticized and hook & loop adjustable sleeves
- // Draw cord at hem

D DRY ZONE VISIBLE JACKE

- // 3M Reflex-Streifen
- // Reißverschluss und Windfang mit Druckknöpfen
- // Versteckte Kapuze mit Kordelzug
- // Ärmelwindfang mit Elastik und Klett
- // Verstellbar an untere Kante

DK DRY ZONE VISIBLE JAKKE

- // 3M Refleksstriber
- // Lynlås og vindfang med trykknapper
- // Skjult hætte med snøretæk
- // Ærmevindfang med elastik samt gribebånd
- // Snøretæk i nedre kant



<p>Size XS - 5XL Size L back length: 76 cm / 30 in Water column main fabric: > 8.000 mm H₂O</p>
<p>EN 343 3 1 EN ISO 20471 3 </p>
<p> 030 FL. ORANGE</p> <p> 040 FL. YELLOW</p>
<p>100% POLYESTER, COATING: POLYURETHANE 190 G/M²</p>
<p></p>



Reinforcement under arm

ART. 022400R

DryZone
Visible
BY ELKA

WATER COLUMN
8.000
MM

EN DRY ZONE VISIBLE WAIST TROUSERS

- // RWS reflective tape
- // Press buttons in leg
- // Reinforced welding on pressure points
- // Elasticated waist

D DRY ZONE VISIBLE BUNDHOSE

- // RWS Reflexstreifen
- // Druckknopf am Bein
- // Verstärkung im Schritt
- // Taillanelastik

DK DRY ZONE VISIBLE TALJEBUKSER

- // RWS refleksstriber
- // Trykknop i ben
- // Forstærket svejsning i skridtet
- // Elastik i taljen



VERTICAL REFLECTIVE TAPE.

<p>Size XS - 5XL Size L inner leg length: 82 cm / 32 in Water column main fabric: > 8.000 mm H₂O</p>
<p>EN 343 3 1 EN ISO 20471 3 </p>
<p> 030 FL. ORANGE</p> <p> 040 FL. YELLOW</p>
<p>100% POLYESTER, COATING: POLYURETHANE 190 G/M²</p>
<p></p>



Reinforcement in crotch

ART. **026301R**

EN DRY ZONE VISIBLE JACKET

- // Reflective tape over shoulders, sleeves & body
- // Hidden / adjustable hood with draw strings
- // Elasticised sleeve and hook & loop adjustment
- // Zipper and double storm flap with press buttons
- // 2 pockets with flaps

D DRY ZONE VISIBLE JACKE

- // Reflexstreifen über Schulter, Ärmel und Body
- // Versteckte Kapuze mit Kordelzug
- // Elastik und Klettverschluss im Ärmel
- // Reißverschluss und doppelte Wetterschutzleiste mit Druckknöpfen
- // 2 Taschen mit Patte

DK DRY ZONE VISIBLE JAKKE

- // Refleksstriber over skuldre, ærmer samt body
- // Skjult hætte med snøretræk
- // Elastik og gribebånd på ærme
- // Lynlås og dobbelt vindfang med trykknapper
- // 2 lommer med klap



Dryzone Visible
BY ELKA

WATER COLUMN
8.000
MM

Size XS - 5XL
Size L back length: 89 cm / 35 in
Water column main fabric: > 8.000 mm H₂O



030 **040**
FL. FL.
ORANGE YELLOW

100% POLYESTER, COATING:
POLYURETHANE 190 G/M²



EXTRA LENGTH.



Reinforcement
under arm

ART. **022401R**

EN DRY ZONE VISIBLE WAIST TROUSERS

- // Elasticated waist with draw strings
- // 2 pocket openings inside seam
- // Cargo- and tool pocket on leg
- // Reinforced welding on pressure points
- // Zipper with inside wind catch on leg

D DRY ZONE VISIBLE BUNDHOSE

- // Elastik im Bund
- // Tascheneingang
- // Cargo- u. Zollstocktasche
- // Verstärkung im Schritt
- // Reißverschluss mit Windfang im Bein

DK DRY ZONE VISIBLE TALJEBUKSER

- // Elastik i talje
- // Lommeindgang
- // Cargo- og tommestok-lomme
- // Forstærket i skridt
- // Lynlås med vindfang i ben



Dryzone Visible
BY ELKA

WATER COLUMN
8.000
MM

Size XS - 5XL
Size L inner leg length: 82 cm / 32 in
Water column main fabric: > 8.000 mm H₂O



030 **040**
FL. FL.
ORANGE YELLOW

100% POLYESTER, COATING:
POLYURETHANE 190 G/M²



Zipper in
legs



Reinforcement
in crotch

ART. 022403R

DryZone
Visible
BY ELKA

WATER COLUMN
8.000
MM

EN DRY ZONE VISIBLE WAIST TROUSERS

- // Reflective tape
- // Press buttons in leg
- // Reinforced welding on pressure points
- // Elasticated waist

D DRY ZONE VISIBLE BUNDHOSE

- // Reflexstreifen
- // Druckknopf am Bein
- // Verstärkung im Schritt
- // Taillanelastik

DK DRY ZONE VISIBLE TALJEBUKSER

- // Refleksstriber
- // Trykknop i ben
- // Forstærket svejsning i skridtet
- // Elastik i taljen



Reinforcement in crotch

<p>Size XS - 5XL Size L inner leg length: 82 cm / 32 in Water column main fabric: > 8.000 mm H₂O</p>
<p>EN 343 3 1 EN ISO 20471 1 </p>
<p> 030 FL. ORANGE</p> <p> 040 FL. YELLOW</p>
<p>100% POLYESTER, COATING: POLYURETHANE 190 G/M²</p>
<p></p>

ART. 028800R

DryZone
Visible
BY ELKA

WATER COLUMN
8.000
MM

EN DRY ZONE VISIBLE BIB & BRACE

- // Reflective tape
- // Press buttons in leg
- // Adjustable suspenders with Fix-lock
- // Reinforced welding on pressure points

D DRY ZONE VISIBLE LATZHOSE

- // Reflexstreifen
- // Druckknopf am Bein
- // Verstellbare Träger mit Fix-lock
- // Verstärkung im Schritt

DK DRY ZONE VISIBLE OVERALL

- // Refleksstriber
- // Trykknop i ben
- // Justerbare seler med Fix-lock spænde
- // Forstærket svejsning i skridtet



Reinforcement in crotch

<p>Size XS - 5XL Size L inner leg length: 72 cm / 28.5 in Water column main fabric: > 8.000 mm H₂O</p>
<p>EN 343 3 1 EN ISO 20471 2 </p>
<p> 030 FL. ORANGE</p> <p> 040 FL. YELLOW</p>
<p>100% POLYESTER, COATING: POLYURETHANE 190 G/M²</p>
<p></p>

ART. **028003R**

EN DRY ZONE VISIBLE COVERALL

- // Hidden hood with draw strings
- // Elasticised in back
- // Zipper and double storm flap with press buttons
- // Elasticised sleeve and hook & loop adjustment
- // Reinforced welding on pressure points

D DRY ZONE VISIBLE OVERALL

- // Versteckte Kapuze mit Kordelzug
- // Elastik im Rücken
- // 2-Wege Reißverschluss und doppelte Wetterschutzleiste mit Druckknöpfen
- // Ärmelwindfang mit Elastik und Klettverschluss
- // Verstärkung im Schritt

DK DRY ZONE VISIBLE HELDRAGT

- // Skjult hætte med snøretræk
- // Elastik i ryg
- // 2-vejs lynlås og dobbelt vindfang med trykknapper
- // Ærmevindfang med elastik samt gribebånd
- // Forstærket i skridt



Reinforcement under arm



Reinforcement in crotch



DryZone Visible
BY ELKA

WATER COLUMN
8.000
MM

Size XS - 5XL
Size L inner leg length: 76 cm / 30 in
Water column main fabric: > 8.000 mm H₂O



030
FL.
ORANGE

100% POLYESTER, COATING:
POLYURETHANE 190 G/M²



ART. **028100R**

EN DRY ZONE VISIBLE THERMAL COVERALL

- // Hidden / adjustable hood with draw strings
- // Zipper and double storm flap with press buttons
- // 2 pockets with hidden snap buttons
- // Sleeves and legs with hook & loop adjustment
- // Smart phone pocket on chest

D DRY ZONE VISIBLE THERMO-OVERALL

- // Versteckte Kapuze mit Kordelzug
- // Reißverschluss und doppelte Wetterschutzleiste mit Druckknöpfen
- // 2 Taschen mit Druckknöpfen
- // Ärmel und Bein verstellbar mit Klettverschluss
- // Brusttasche mit Smartphone-Tasche

DK DRY ZONE VISIBLE TERMO HELDRAGT

- // Skjult hætte med snøretræk
- // Lynlås og dobbelt vindfang med trykknapper
- // 2 Lommer med trykknapper
- // Justerbare ærmer og ben med gribebånd
- // Brystlomme til mobil



Winter



Zipper in legs



DryZone Visible
BY ELKA

WATER COLUMN
8.000
MM

Size S - 5XL
Size L inner leg length: 76 cm / 30 in
Water column main fabric: > 8.000 mm H₂O



031
FL. ORANGE/
NAVY

100% POLYESTER, COATING:
POLYURETHANE 190 G/M²







MADE IN EUROPE

EN

For more than 60 years, ELKA has been producing waterproof workwear at our own factories in Europe. Our know-how ensures a high, consistent quality and a flexible production set-up with a delivery time of 4-6 weeks. We use European fabric and trim in our **Made in Europe** collections and we work closely with carefully selected subcontractors, all of whom stand for high quality requirements, including REACH.

The **Made in Europe** collection contains a wide range of products, all with the common feature that they are produced at our plant in Lithuania. We are experts in PU and PVC high frequency welding, which is the absolute strongest production technology for waterproof workwear in these materials. The result is PU and PVC products with a high water column pressure of 10,000 / 20,000 mm - with both waterproof fabric and waterproof seams.

D

ELKA produziert seit über 60 Jahren in eigenen Werken in Europa. Unser Know-how gewährleistet eine hohe, gleichbleibende Qualität und einen flexiblen Produktionsaufbau mit einer Lieferzeit von 4-6 Wochen. Wir verwenden europäische Stoffe und Besätze in unseren **Made in Europe** Kollektionen und arbeiten eng mit sorgfältig ausgewählten Subunternehmen zusammen, die alle für hohe Qualitätsanforderungen, einschließlich REACH, stehen.

Die **Made in Europe**-Kollektion umfasst eine breite Palette von Produkten, die alle gemeinsam haben, dass sie in unserem Werk in Litauen hergestellt werden. Wir sind Experten für PU- und PVC-Hochfrequenzschweißen, die absolut stärkste Produktionstechnologie für wasserdichte Arbeitskleidung aus diesen Materialien. Das Ergebnis sind PU- und PVC-Produkte mit einem hohen Wassersäulendruck von 10.000 / 20.000 mm – mit wasserdichtem Gewebe und wasserdichten Nähten.

DK

I mere end 60 år har ELKA produceret varer på vores egne fabrikker i Europa. Vores know-how sikrer en høj, ensartet kvalitet og et fleksibelt produktionsset-up med leveringstid på 4-6 uger. Vi benytter europæiske metervarer og trim i vores **Made in Europe**-kollektioner og arbejder tæt sammen med nøje udvalgte underleverandører, som alle står inde for krav om høj kvalitet, herunder REACH.

Made in Europe-kollektionen indeholder en bred vifte af produkter, alle med det fælles træk, at de er produceret på vores fabrik i Litauen. Vi er eksperter i PU og PVC højfrekvenssvejsning, som er den absolut stærkeste produktionsteknologi til vandtæt arbejdstøj i disse materialer. Resultatet er PU og PVC produkter med højt vandsøjletryk på 10.000/20.000 mm – med både vandtæt metervare og vandtætte sømme.

ART. 076300

MADE IN EUROPE
ELKA PRO

WATER COLUMN
20.000
MM

EN ELKA PRO JACKET

- // Hidden hood with cord
- // YKK zipper with storm flap
- // 2 pockets with flaps
- // Elasticated sleeves and elasticated hem

D ELKA PRO JACKE

- // Versteckte Kapuze mit Kordel
- // YKK-Reißverschluss und Wetterschutzleiste
- // 2 Taschen mit Patte
- // Elastik in den Ärmel und am Rücken

DK ELKA PRO JAKKE

- // Skjult hætte med snor
- // YKK-lynlås og vindfang
- // 2 lommer med klap
- // Elastik i ærmer og nederst på ryggen



Size XS - 5XL
 Size L back length: 70 cm / 27.5 in
 Water column main fabric: > 20.000 mm H₂O

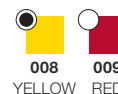
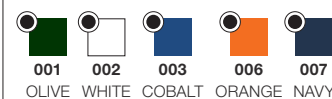
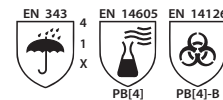

- STOCK ITEM
 - SPECIAL ORDER
- Please accept minimum 5 pieces pr. size (within size range XS - 5XL)

100% POLYAMIDE, COATING:
POLYURETHANE 240 G/M²



ART. 072400

MADE IN EUROPE
ELKA PRO

WATER COLUMN
20.000
MM

EN ELKA PRO WAIST TROUSERS

- // Elasticated waist
- // Press buttons in leg
- // Reinforcement in crotch

D ELKA PRO BUNDHOSE

- // Elastik im Bund
- // Druckknopf am Bein
- // Verstärkung im Schritt

DK ELKA PRO TALJEBUKS

- // Elastik i taljen
- // Trykknapper i ben
- // Forstærkning i skridtet



Size XS - 5XL
 Size L inner leg length: 82 cm / 32 in
 Water column main fabric: > 20.000 mm H₂O

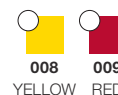
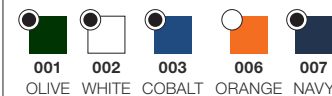
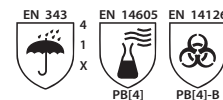

- STOCK ITEM
 - SPECIAL ORDER
- Please accept minimum 5 pieces pr. size (within size range XS - 5XL)

100% POLYAMIDE, COATING:
POLYURETHANE 240 G/M²



Reinforcement
in crotch

ART. **077100**

EN ELKA PRO SMOCK

- // Fixed hood with adjustable cord
- // Press button in neck
- // Reinforcement under arm

D ELKA PRO SCHLUPFJACKE

- // Feste Kapuze mit verstellbare Kordelzug
- // Druckknopf am Hals
- // Verstärkung unter dem Arm

DK ELKA PRO BUSSERONNE

- // Fast hætte med justerbar snøretræk
- // Trykknop i hals
- // Forstærkning under arm



Reinforcement under arm

MADE IN EUROPE
ELKA PRO

WATER COLUMN
20.000
MM

Size XS - 5XL
Size L back length: 71 cm / 28 in
Water column main fabric: > 20.000 mm H₂O

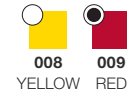
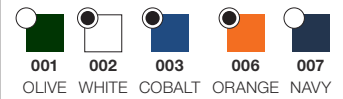
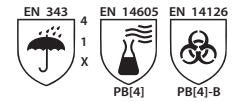

- STOCK ITEM
- SPECIAL ORDER
Please accept minimum 5 pieces pr. size (within size range XS - 5XL)

100% POLYAMIDE, COATING:
POLYURETHANE 240 G/M²



ART. **077100E**

EN ELKA PRO SMOCK W/ELASTIC

- // Fixed hood with adjustable cord
- // Press button in neck
- // Elasticated sleeves
- // Reinforcement under arm

D ELKA PRO SCHLUPFJACKE M/ELASTIK

- // Feste Kapuze mit verstellbare Kordelzug
- // Druckknopf am Hals
- // Elastik am Ärmel
- // Verstärkung unter dem Arm

DK ELKA PRO BUSSERONNE M/ELASTIK

- // Fast hætte med justerbar snøretræk
- // Trykknop i hals
- // Elastik i ærmer
- // Forstærkning under arm



Reinforcement under arm

MADE IN EUROPE
ELKA PRO

WATER COLUMN
20.000
MM

Size XS - 5XL
Size L back length: 71 cm / 28 in
Water column main fabric: > 20.000 mm H₂O

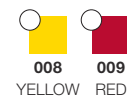
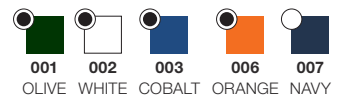
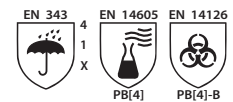

- STOCK ITEM
- SPECIAL ORDER
Please accept minimum 5 pieces pr. size (within size range XS - 5XL)

100% POLYAMIDE, COATING:
POLYURETHANE 240 G/M²



ART. 079800E

MADE IN EUROPE
ELKA PRO

WATER COLUMN
20.000
MM

EN ELKA PRO JACKET

- // Elasticated fixed hood
- // Press buttons in front and hidden storm flap
- // Elasticated sleeves

D ELKA PRO JACKE

- // Feste Kapuze mit Gummizug
- // Druckknöpfe auf der Vorderseite und versteckte Windschutz
- // Elastik am Ärmel

DK ELKA PRO JAKKE

- // Fast hætte med elastik
- // Trykknapper på front med indvendig vindfang
- // Elastik i ærmer



Size XS - 5XL
Size L back length: 77 cm / 30 in
Water column main fabric: > 20.000 mm H₂O

EN 343 4
1
X

001 002 003 006 007
OLIVE WHITE COBALT ORANGE NAVY

008 009
YELLOW RED

STOCK ITEM
 SPECIAL ORDER
Please accept minimum 5 pieces pr. size (within size range XS - 5XL)

100% POLYAMIDE, COATING: POLYURETHANE 240 G/M²

60 MAX. 25X

ART. 078000

MADE IN EUROPE
ELKA PRO

WATER COLUMN
20.000
MM

EN ELKA PRO COVERALL

- // Fixed hood with adjustable cord
- // YKK zipper with storm flap
- // Elasticated sleeves
- // Press button in leg
- // Reinforcement under arm and in crotch

D ELKA PRO OVERALL

- // Feste Kapuze mit verstellbare Kordelzug
- // YKK-Reißverschluss und Wetterschutzleiste
- // Elastik am Ärmel
- // Druckknopf am Bein
- // Verstärkung unter dem Arm und im Schritt

DK ELKA PRO HELDRAGT

- // Fast hætte med justerbar snøretæk
- // YKK-lynlås og vindfang
- // Elastik i ærmer
- // Trykknop i ben
- // Forstærkning under arm og i skridtet



Size XS - 4XL
Size L inner leg length: 76 cm / 30 in
Water column main fabric: > 20.000 mm H₂O

EN 343 4
1
X

EN 14605 EN 14126
TYPE 4 TYPE 4-B

001 002 003 006 007
OLIVE WHITE COBALT ORANGE NAVY

008 009
YELLOW RED

STOCK ITEM
 SPECIAL ORDER
Please accept minimum 5 pieces pr. size (within size range XS - 4XL)

100% POLYAMIDE, COATING: POLYURETHANE 240 G/M²

60 MAX. 25X



Reinforcement under arm

Reinforcement in crotch

ART. 079900

EN ELKA PRO BIB & BRACE

- // Front to back reversibility
- // Adjustable suspenders with Fix-lock
- // Reinforcement in crotch

D ELKA PRO LATZHOSE

- // Wendbare Latzhose
- // Verstellbare Träger mit Fix-lock
- // Verstärkung im Schritt

DK ELKA PRO OVERALL

- // Vendbar overall
- // Justerbare seler med Fix-lock spænde
- // Forstærkning i skridtet



Reinforcement in crotch



Reversible

MADE IN EUROPE
ELKA PRO

WATER COLUMN
20.000
MM

Size XS - 5XL

Size L inner leg length: 72 cm / 28.5 in
Water column main fabric: > 20.000 mm H₂O

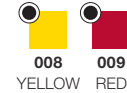
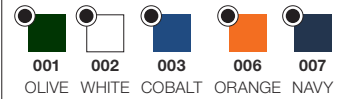
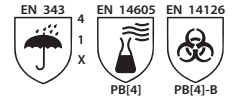

- STOCK ITEM
- SPECIAL ORDER
Please accept minimum 5 pieces pr. size (within size range XS - 5XL)

100% POLYAMIDE, COATING:
POLYURETHANE 240 G/M²



ART. 079900E

EN ELKA PRO BIB & BRACE W/ ELASTIC

- // Front to back reversibility
- // Adjustable suspenders with Fix-lock
- // Elasticated legs
- // Reinforcement in crotch

D ELKA PRO LATZHOSE M/ ELASTIK

- // Wendbare Latzhose
- // Verstellbare Träger mit Fix-lock
- // Elastik am Bein
- // Verstärkung im Schritt

DK ELKA PRO OVERALL M/ ELASTIK

- // Vendbar overall
- // Justerbare seler med Fix-lock spænde
- // Elastik i ben
- // Forstærkning i skridtet



Reinforcement in crotch



Reversible

MADE IN EUROPE
ELKA PRO

WATER COLUMN
20.000
MM

Size XS - 5XL

Size L inner leg length: 72 cm / 28.5 in
Water column main fabric: > 20.000 mm H₂O

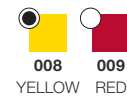
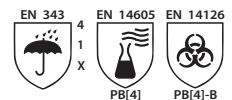

- STOCK ITEM
- SPECIAL ORDER
Please accept minimum 5 pieces pr. size (within size range XS - 5XL)

100% POLYAMIDE, COATING:
POLYURETHANE 240 G/M²



ART. **079902**

EN ELKA PRO BIB & BRACE W/ KNEE REINFORCEMENT

- // Front to back reversibility
- // Adjustable suspenders with fix-lock
- // Elasticated legs
- // Reinforced on the knees, both front and back
- // Reinforcement in crotch

D ELKA PRO LATZHOSE M/ KNEIEVERSTÄRKUNG

- // Wendbare Latzhose
- // Verstellbare Träger mit Fix-lock
- // Elastik am Bein
- // Verstärkung am Knie, sowohl vorne als auch hinten
- // Verstärkung im Schritt

DK ELKA PRO OVERALL M/ KNÆFORSTÆRKNING

- // Vendbar overall
- // Justerbare seler med Fix-lock spænde
- // Elastik i ben
- // Forstærket ved knæet, både foran og bagpå
- // Forstærkning i skridtet



Reinforcement in crotch



Reinforcement around knee



Reversible



MADE IN EUROPE
ELKA PRO

WATER COLUMN
20.000
MM

Size XS - 5XL

Size L inner leg length: 72 cm / 28.5 in
Water column main fabric: > 20.000 mm H₂O

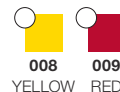
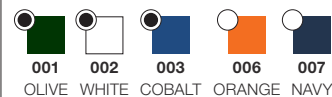
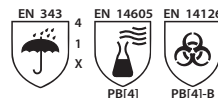

STOCK ITEM

SPECIAL ORDER

Please accept minimum 5 pieces pr. size (within size range XS - 5XL)

100% POLYAMIDE, COATING: POLYURETHANE 240 G/M²



ART. **079904**

EN ELKA PRO BIB & BRACE W/ POCKETS FOR KNEE PADS

- // Adjustable suspenders with fix-lock
- // Elasticated legs
- // Pockets for knee pads
- // Reinforcement in crotch

D ELKA PRO LATZHOSE M/ TASCHE FÜR KNEIPOLSTER

- // Verstellbare Träger mit Fix-lock
- // Elastik am Bein
- // Tasche für Kniepolster
- // Verstärkung im Schritt

DK ELKA PRO OVERALL M/ LOMMER TIL KNÆPUDER

- // Justerbare seler med Fix-lock
- // Elastik i ben
- // Lommer til knæpuder
- // Forstærkning i skridtet



Reinforcement in crotch



Pockets for knee pads



MADE IN EUROPE
ELKA PRO

WATER COLUMN
20.000
MM

Size XS - 5XL

Size L inner leg length: 72 cm / 28.5 in
Water column main fabric: > 20.000 mm H₂O

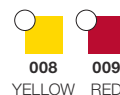
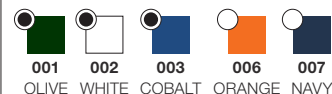
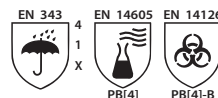

STOCK ITEM

SPECIAL ORDER

Please accept minimum 5 pieces pr. size (within size range XS - 5XL)

100% POLYAMIDE, COATING: POLYURETHANE 240 G/M²



**POCKETS FOR KNEE PADS:
ART. 3250 AND ART. 3260 ARE
SUITABLE, SEE PAGE 111.**

ART. 075810

EN ELKA FOOD APRON W/LOOPS FOR BRACES G&F

- // With loops for braces
- // Art. 3320 braces fits apron
- // Art. 3320 are sold separately
- // Width in size L: 90 cm / 35.5 in
- // Length in size L: 120 cm / 47 in

D ELKA FOOD SCHÜRZE M/ÖSEN FÜR GESCHIRR G&G

- // Mit Ösen für Geschirr
- // Art. 3320 Geschirr passend für Schürze
- // Art. 3320 muss zugekauft werden
- // Weite in Größe L: 90 cm
- // Länge in Größe L: 120 cm

DK ELKA FOOD FORKLÆDE M/RINGE TIL SELER G&G

- // Med ringe til seler
- // Art. 3320 seler passer til forklædet
- // Art. 3320 sælges separat
- // Bredde i str. L: 90 cm
- // Længde i str. L: 120 cm



ART. 075810 IS SHOWN WITH ART. 3320 BRACES. THE BRACES ARE AVAILABLE IN WHITE AND COBALT. SOLD SEPARATELY.

MADE IN EUROPE
ELKA FOOD

WATER COLUMN
10.000
MM

Size S - XL			
Water column main fabric: > 10.000 mm H ₂ O			
EN 343 4 1 X 	EN 1186 	EN 14605 	EN 14126
PB[4]		PB[4]-B	
002	003	WHITE COBALT	
100% POLYAMIDE, COATING: POLYURETHANE 240 G/M ²			

ART. 3320

BRACES FOR APRON



ART. 035700

EN APRON W/STRINGS

D SCHÜRZE M/KORDELZUG

DK FORKLÆDE M/SNØRE



Fish oil resistant



Cold resistant

MADE IN EUROPE

WATER COLUMN
15.000
MM

One size Width: 88 cm / 34 in Length: 116 cm / 45.5 in Water column main fabric: > 15.000 mm H ₂ O
EN 343 3 1
 001 002 003 007 OLIVE WHITE COBALT NAVY 008 009 010 YELLOW RED BLACK
<input checked="" type="radio"/> STOCK ITEM <input type="radio"/> SPECIAL ORDER Please accept minimum 5 pieces
100% POLYESTER, COATING: PVC 320 G/M ²

ART. 175809

EN APRON W/BRACES

D SCHÜRZE M/TRÄGER

DK FORKLÆDE M/SELE



Fish oil resistant



Cold resistant

MADE IN EUROPE

WATER COLUMN
15.000
MM

Size S - XL Width in size L: 90 cm / 35 in Length in size L: 115 cm / 45.5 in Water column main fabric: > 15.000 mm H ₂ O
EN 343 3 1
 001 002 007 OLIVE WHITE NAVY
100% POLYESTER, COATING: PVC 600 G/M ²

ART. 076300R

MADE IN EUROPE

WATER COLUMN
10.000
MM

EN JACKET

- // Hidden / adjustable hood
- // YKK zipper and storm flap
- // 2 pockets with flap
- // Elasticated sleeves and elasticated hem
- // Reflective tape

D JACKE

- // Versteckte Kapuze mit Kordelzug
- // YKK-Reißverschluss und Wetterschutzleiste
- // 2 Taschen
- // Elastik in den Ärmel und am Rücken
- // Reflexstreifen

DK JAKKE

- // Skjult hætte med snøretræk
- // YKK-lynlås og vindfang
- // 2 lommer med klap
- // Elastik i ærmer og nederst på ryggen
- // Refleksstriber



Size S - 3XL

Size L back length: 73 cm / 28.5 in

Water column main fabric: > 10.000 mm H₂O



<input checked="" type="radio"/> 030 FL. ORANGE	<input type="radio"/> 031 FL. ORANGE/ NAVY	<input checked="" type="radio"/> 033 FL. ORANGE/ BLACK
<input type="radio"/> 040 FL. YELLOW	<input checked="" type="radio"/> 041 FL. YELLOW/ NAVY	<input type="radio"/> 042 FL. YELLOW/ BLACK

STOCK ITEM

SPECIAL ORDER

Please accept minimum 5 pieces pr. size (within size range S - 3XL)

100% POLYAMIDE, COATING:
POLYURETHANE 210 G/M²



ART. 072400R

MADE IN EUROPE

WATER COLUMN
10.000
MM

EN WAIST TROUSERS

- // Elasticated waist
- // Press button in leg
- // Reflective tape

D BUNDHOSE

- // Elastik im Bund
- // Druckknopf am Bein
- // Reflexstreifen

DK TALJEBUKS

- // Elastik i taljen
- // Trykknop i ben
- // Refleksstriber



Size S - 3XL

Size L inner leg length: 82 cm / 32 in

Water column main fabric: > 10.000 mm H₂O



<input type="radio"/> 030 FL. ORANGE	<input type="radio"/> 031 FL. ORANGE/ NAVY	<input checked="" type="radio"/> 033 FL. ORANGE/ BLACK
<input type="radio"/> 040 FL. YELLOW	<input checked="" type="radio"/> 041 FL. YELLOW/ NAVY	<input type="radio"/> 042 FL. YELLOW/ BLACK

STOCK ITEM

SPECIAL ORDER

Please accept minimum 5 pieces pr. size (within size range S - 3XL)

100% POLYAMIDE, COATING:
POLYURETHANE 210 G/M²



Reinforcement
in crotch

ART. **079800R**

EN JACKET

- // Elasticated fixed hood
- // Press buttons in front
- // Press buttons in sleeves
- // Reflective tape

D JACKE

- // Feste Kapuze mit Gummizug
- // Druckknöpfe im Front
- // Druckknöpfe am Ärmel
- // Reflexstreifen

DK JAKKE

- // Fast hætte med elastik
- // Trykknapper foran
- // Trykknapper i ærmer
- // Refleksstriber



MADE IN EUROPE

WATER COLUMN
10.000
MM

Size S - 3XL

Size L back length: 79 cm / 31 in
Water column main fabric: > 10.000 mm H₂O



- | | | |
|---|---|--|
| <input checked="" type="radio"/> 030
FL. ORANGE | <input type="radio"/> 031
FL. ORANGE/
NAVY | <input type="radio"/> 033
FL. ORANGE/
BLACK |
| <input type="radio"/> 040
FL. YELLOW | <input type="radio"/> 041
FL. YELLOW/
NAVY | <input type="radio"/> 042
FL. YELLOW/
BLACK |

STOCK ITEM

SPECIAL ORDER

Please accept minimum 5 pieces pr. size (within size range S - 3XL)

100% POLYAMIDE, COATING:
POLYURETHANE 210 G/M²



ART. **078800R**

EN BIB & BRACE

- // Front to back reversibility
- // Adjustable suspenders with Fix-lock
- // Press button in leg
- // Reflective tape

D LATZHOSE

- // Wendbare Latzhose
- // Ferstellbare Träger mit Fix-lock
- // Druckknöpfe am Bein
- // Reflexstreifen

DK OVERALL

- // Vendbar overall
- // Justerbare seler med Fix-lock spænde
- // Trykknapper i ben
- // Refleksstriber



MADE IN EUROPE

WATER COLUMN
10.000
MM

Size S - 3XL

Size L inner leg length: 72 cm / 28.5 in
Water column main fabric: > 10.000 mm H₂O



- | | | |
|---|---|--|
| <input checked="" type="radio"/> 030
FL. ORANGE | <input type="radio"/> 031
FL. ORANGE/
NAVY | <input type="radio"/> 033
FL. ORANGE/
BLACK |
| <input type="radio"/> 040
FL. YELLOW | <input type="radio"/> 041
FL. YELLOW/
NAVY | <input type="radio"/> 042
FL. YELLOW/
BLACK |

STOCK ITEM

SPECIAL ORDER

Please accept minimum 5 pieces pr. size (within size range S - 3XL)

100% POLYAMIDE, COATING:
POLYURETHANE 210 G/M²



Reinforcement
in crotch



Reversible

ART. 078000R

MADE IN EUROPE

WATER COLUMN
10.000
MM

EN COVERALL

- // Adjustable hood
- // YKK zipper with storm flap
- // Press button in leg
- // Reflective tape

D OVERALL

- // Feste Kapuze mit Kordelzug
- // YKK-Reißverschluss und Wetterschutzleiste
- // Druckknopf am Bein
- // Reflexstreifen

DK HELDRAGT

- // Fast hætte med snøretræk
- // YKK-lynlås og vindfang
- // Trykknop i ben
- // Refleksstriber



Reinforcement under arm



Reinforcement in crotch

Size XS-4XL

Size L inner leg length: 76 cm / 30 in
Water column main fabric: > 10.000 mm H₂O



<input checked="" type="radio"/> 030 FL. ORANGE	<input type="radio"/> 031 FL. ORANGE/ NAVY	<input type="radio"/> 033 FL. ORANGE/ BLACK
<input type="radio"/> 040 FL. YELLOW	<input type="radio"/> 041 FL. YELLOW/ NAVY	<input type="radio"/> 042 FL. YELLOW/ BLACK

STOCK ITEM

SPECIAL ORDER

Please accept minimum 5 pieces pr. size (within size range XS - 4XL)

100% POLYAMIDE, COATING:
POLYURETHANE 210 G/M²



ART. 018001

MADE IN EUROPE

WATER COLUMN
10.000
MM

EN COVERALL

- // Adjustable hood
- // YKK zipper with storm flap
- // Windbreak inside sleeve w/elastic
- // Press button in leg

D OVERALL

- // Feste Kapuze mit Kordelzug
- // YKK-Reißverschluss und Wetterschutzleiste
- // Elastikwindfang in den Ärmeln
- // Druckknopf am Bein

DK HELDRAGT

- // Fast hætte med snøretræk
- // YKK-lynlås og vindfang
- // Indvendig ærme vindfang med elastik
- // Trykknop i ben



Reinforcement under arm



Reinforcement in crotch

Size XS - 4XL

Size L inner leg length: 76 cm / 30 in
Water column main fabric: > 10.000 mm H₂O

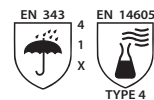

<input type="radio"/> 001 OLIVE	<input checked="" type="radio"/> 006 ORANGE	<input type="radio"/> 007 NAVY
------------------------------------	--	-----------------------------------

STOCK ITEM

SPECIAL ORDER

Please accept minimum 5 pieces pr. size (within size range XS - 4XL)

100% POLYAMIDE, COATING:
POLYURETHANE 170 G/M²



ART. 092200

EN SMOCK / BIB & BRACE

Smock

- // Hood with draw strings
- // Press button in neck

Trousers

- // Adjustable suspenders with fix lock
- // Double-welded inner seams
- // Fish oil and cold resistant

D SCHLUPFJACKE / LATZHOSE

Schlupfjacke

- // Kapuze mit Kordelzug
- // Druckknopf am Hals

Latzhose

- // Verstellbare Träger mit Fix-lock
- // Fischöl- und kältebeständig

DK BUSSERONNE / OVERALL

Busseronne

- // Hætte med snøretræk
- // Trykknop i hals

Overalls

- // Justerbare seler med Fix-lock
- // Dobbeltsejtsede indersømme
- // Fiskeolie-resistent og kuldebestandig



MADE IN EUROPE

WATER COLUMN
15.000
MM

Size XS-4XL
Size L back length: 71 cm / 28 in
Size L inner leg length: 72 cm / 28.5 in
Water column main fabric: > 15.000 mm H₂O

EN 343 3 1

006
ORANGE

100% POLYESTER, COATING: PVC 320 G/M²



Fish oil resistant



Cold resistant



Reinforcement under arm



Reinforcement in crotch

FLEXIBLE PRODUCTION MEETS INDIVIDUAL NEEDS

At ELKA, we also develop and produce special solutions in close cooperation with customers.

We offer adjustments of existing models, possibly logo printing and individual total solutions. Draw on our know-how and let us help you find the perfect solution.

This coverall, art. 079000, is specially developed for work in sewers. With welded boots and a specially adapted horizontal closure at the top of the back, the style is ideal for working in wet environments underground.

The style can be adapted individually with safety boots and gloves. It's an example of how we are able to customize a product to individual needs. See the form below for further information.



ART. 079000



AVAILABLE WITH GLOVES WELDED ON.



AVAILABLE WITH EN ISO 20345 S5 SRA SAFETY BOOTS WELDED ON.

DELIVERY TIME ON THIS COVERALL IS 2-3 WEEKS.

MADE IN EUROPE

WATER COLUMN
15.000
MM

Boot size 36-42: Coverall size M
Boot size 43-50: Coverall size L
Water column main fabric: > 15.000 mm H₂O

EN 343 3 1

006
ORANGE

100% POLYAMIDE, COATING: POLYURETHANE 240 G/M² /
100% POLYESTER, COATING: PVC 600 G/M²

ART. NO.	COVERALL	GLOVES	DUNLOP BOOTS	DUNLOP SAFETY BOOTS
079000	•		•	
0790AA	•	•	•	
079200	•			•
0792AA	•	•		•

ART. 033800

MADE IN EUROPE

WATER COLUMN
15.000
MM

EN JACKET

- // Elasticated hood
- // Press buttons
- // Fish oil and cold resistant

D JACKE

- // Kapuze mit Elastik
- // Druckknöpf
- // Fischöl- und kältebeständig

DK JAKKE

- // Hætte med elastik
- // Trykknapper
- // Fiskeolie-resistent og kuldebestandig



Fish oil resistant



Cold resistant

Size XS -5XL
Size L back length: 79 cm / 31 in
Water column main fabric: > 15.000 mm H₂O

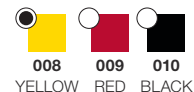
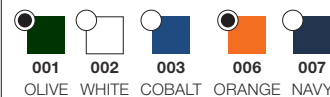

- STOCK ITEM
 - SPECIAL ORDER
- Please accept minimum 5 pieces pr. size (within size range XS - 5XL)

100% POLYESTER, COATING: PVC 320 G/M²



ART. 036600

MADE IN EUROPE

WATER COLUMN
15.000
MM

EN JACKET

- // Elasticated hood
- // Elasticated sleeves
- // YKK zipper with storm flap
- // Fish oil and cold resistant

D JACKE

- // Kapuze mit Elastik
- // Elastik im Ärmel
- // YKK-Reißverschluss und Wetterschutzleiste
- // Fischöl- und kältebeständig

DK JAKKE

- // Hætte med elastik
- // Elastik i ærmer
- // YKK-lynlås og vindfang
- // Fiskeolie-resistent og kuldebestandig



Fish oil resistant



Cold resistant

Size S-5XL
Size L back length: 73 cm / 28.5 in
Water column main fabric: > 15.000 mm H₂O

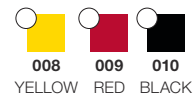
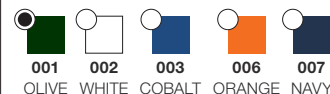

- STOCK ITEM
 - SPECIAL ORDER
- Please accept minimum 5 pieces pr. size (within size range S - 5XL)

100% POLYESTER, COATING: PVC 320 G/M²



ART. 037100

EN SMOCK

- // Adjustable hood
- // Press button in neck
- // Fish oil and cold resistant

D SCHLUPFJACKE

- // Kapuze mit Kordelzug
- // Druckknopf am Hals
- // Fischöl- und kältebeständig

DK BUSSERONNE

- // Hætte med snøretræk
- // Trykknop i hals
- // Fiskeolie-resistent og kuldebestandig



MADE IN EUROPE

WATER COLUMN
15.000
MM

Size XS-5XL

Size L back length: 71 cm / 28 in
Water column main fabric: > 15.000 mm H₂O

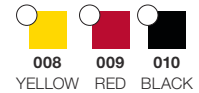
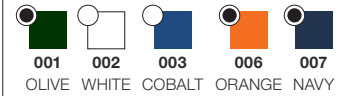

- STOCK ITEM
- SPECIAL ORDER
Please accept minimum 5 pieces pr. size (within size range XS - 5XL)

100% POLYESTER, COATING: PVC 320 G/M²



Fish oil resistant



Cold resistant



Reinforcement under arm

ART. 097600

EN PVC LIGHT HUNTING SMOCK

- // Elasticated hood
- // Front pocket
- // Press button in neck
- // Extra long design
- // Fish oil and cold resistant

D PVC LIGHT JAGDSCHLUPFJACKE

- // Kapuze mit Kordelzug
- // 1 Taschen
- // Druckknopf am Hals
- // Extralänge
- // Fischöl- und kältebeständig

DK PVC LIGHT JAGTBUSSERONNE

- // Justerbar hætte
- // Frontlomme
- // Trykknop i hals
- // Ekstra længde
- // Fiskeolie-resistent og kuldebestandig



MADE IN EUROPE

WATER COLUMN
15.000
MM

Size XS - 5XL

Size L back length: 86 cm / 34 in
Water column main fabric: > 15.000 mm H₂O

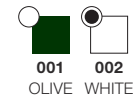

- STOCK ITEM
- SPECIAL ORDER
Please accept minimum 5 pieces pr. size (within size range XS - 5XL)

100% POLYESTER, COATING: PVC 320 G/M²



Fish oil resistant



Cold resistant



Reinforcement under arm

ART. 039900

MADE IN EUROPE

WATER COLUMN
15.000
MM

EN BIB & BRACE

- // Front to back reversibility
- // Adjustable suspenders with fix lock
- // Fish oil and cold resistant

D LATZHOSE

- // Wendbare Latzhose
- // Verstellbare Träger mit Fix-lock
- // Fischöl- und kältebeständig

DK OVERALL

- // Vendbar overall
- // Justerbare seler med Fix-lock
- // Fiskeolie-resistent og kuldebestandig



Fish oil resistant



Cold resistant



Reinforcement in crotch



Reversible



Size XS-5XL
Size L inner leg length: 72 cm / 28.5 in
Water column main fabric: > 15.000 mm H₂O



- STOCK ITEM
 - SPECIAL ORDER
- Please accept minimum 5 pieces pr. size (within size range XS - 5XL)

100% POLYESTER, COATING: PVC 320 G/M²



ART. 032400

MADE IN EUROPE

WATER COLUMN
15.000
MM

EN WAIST TROUSERS

- // Elasticated waist
- // Press buttons in legs
- // Fish oil and cold resistant

D BUNDHOSE

- // Elastik im Bund
- // Druckknopf am Bein
- // Fischöl- und kältebeständig

DK TALJEBUKSER

- // Elastik i taljen
- // Trykknapper i ben
- // Fiskeolie-resistent og kuldebestandig



Fish oil resistant



Cold resistant



Reinforcement in crotch



Size XS-5XL
Size L inner leg length: 82 cm / 32 in
Water column main fabric: > 15.000 mm H₂O



- STOCK ITEM
 - SPECIAL ORDER
- Please accept minimum 5 pieces pr. size (within size range XS - 5XL)

100% POLYESTER, COATING: PVC 320 G/M²



ART. 179909

EN ELASTOMER/PVC BIB & BRACE

- // Front to back reversibility
- // Adjustable suspenders with fix-lock
- // Fish oil and cold resistant

D ELASTOMER/PVC LATZHOSE

- // Wendbare Latzhose
- // Verstellbare Träger mit Fix-lock
- // Fischöl- und kältebeständig

DK ELASTOMER/PVC OVERALL

- // Vendbar overall
- // Justerbare seler med Fix-lock spænde
- // Fiskeolie-resistent og kuldebestandig



MADE IN EUROPE

WATER COLUMN
15.000
MM

Size XS - 5XL

Size L inner leg length: 72 cm / 28.5 in
Water column main fabric: > 15.000 mm H₂O



001
OLIVE

100% POLYESTER, COATING: PVC 600 G/M²



Fish oil resistant



Cold resistant



Reinforcement in crotch



Reversible

ART. 177101

EN SMOCK

- // Adjustable hood
- // Double-welded side seams
- // Reinforced in welded stress-points
- // Welded seam in sleeves
- // Fish oil and cold resistant

D SCHLUPFJACKE

- // Feste Kapuze mit Kordelzug
- // Dobbelt versvejsede Seitennåte
- // Forstærket Schwejsning im beanspruchten Nähten
- // Versvejsede Nåde im Ärmel
- // Fischöl- und kältebestandig

DK BUSSERONNE

- // Hætte med snøretræk
- // Dobbelt svejsede sidesømme
- // Forstærket svejsning i belastede sømme
- // Svejsede opsøm i ærmer
- // Fiskeolie-resistent og kuldebestandig



MADE IN EUROPE

WATER COLUMN
15.000
MM

Size XS - 5XL

Size L back length: 84 cm / 33 in
Water column main fabric: > 15.000 mm H₂O



001
OLIVE

100% POLYESTER, COATING: PVC 600 G/M²



Fish oil resistant



Cold resistant



Reinforcement under arm

ART. 179801

MADE IN EUROPE

WATER COLUMN
15.000
MM

EN JACKET

- // Adjustable hood
- // Double-welded side seams
- // Reinforced in welded stress-points
- // Welded seam in sleeves
- // Press buttons closure and double wind catch

D JACKE

- // Feste Kapuze mit Kordelzug
- // Dobbelt versvæjste Seitennåte
- // Forstærket svejsning i belastede sømme
- // Versvæjste Nåte im Ärmel
- // Verstærkte Schweißung im beanspruchten Nähten

DK JAKKE

- // Hætte med snøretræk
- // Dobbeltvejsede sidesømme
- // Forstærket svejsning i belastede sømme
- // Svejsede opsøm i ærmer
- // Trykknop-lukning og dobbelt vindfang



<p>Size XS - 5XL Size L back length: 79 cm / 31 in Water column main fabric: > 15.000 mm H₂O</p>
<p>100% POLYESTER, COATING: PVC 600 G/M²</p>



Fish oil resistant



Cold resistant

ART. 179806

ART. 179806C

MADE IN EUROPE

WATER COLUMN
15.000
MM

EN JACKET

- // Elasticated hood
- // Double-welded side seams
- // Reinforced in welded stress-points
- // YKK zipper and hook & loop behind wind catch

D JACKE

- // Kapuze mit Kordelzug
- // Dobbelt versvæjste Seitennåte
- // Verstærkte Schweißung in den beanspruchten Nähten
- // YKK-Reißverschluss verdeckt mit Wetterschutzleiste mit Klettverschluss

DK JAKKE

- // Hætte med elastik
- // Dobbeltvejsede sidesømme
- // Forstærket svejsning i belastede sømme
- // YKK-lynslås og gribebånd bag vindfang



ART. 179806:
ELASTICATED WIND
CATCH IN SLEEVES.

ART. 179806C:
LATEX CUFF IN
SLEEVES.

<p>Size XS - 5XL Size L back length: 78 cm / 30.5 in Water column main fabric: > 15.000 mm H₂O</p>
<p>100% POLYESTER, COATING: PVC 600 G/M²</p>



Fish oil resistant



Cold resistant

ART. 177301

EN BIB & BRACE

- // Front to back reversibility
- // Inside pocket
- // Adjustable suspenders with Fix-lock
- // Fish oil and cold resistant

D LATZHOSE

- // Wendbare Latzhose
- // Innentasche
- // Verstellbare Träger mit Fix-lock
- // Fischöl- und kältebeständig

DK OVERALL

- // Vendbar overall
- // Inderlomme
- // Justerbare seler med Fix-lock
- // Fiskeolie-resistent og kuldebestandig



MADE IN EUROPE

WATER COLUMN
15.000
MM

Size XS-5XL

Size L inner leg length: 73 cm / 28.5 in
Water column main fabric: > 15.000 mm H₂O



001
OLIVE

100% POLYESTER, COATING: PVC 600 G/M²



Fish oil resistant



Cold resistant



Reinforcement in crotch



Reversible

ART. 177303

EN BIB & BRACE W/ KNEE REINFORCEMENT

- // Knee reinforcement and welded knee patch
- // Inside pocket
- // Adjustable suspenders with Fix-lock
- // Fish oil and cold resistant

D LATZHOSE M/KNIEVERSTÄRKUNG

- // Integrierte Kniepolster
- // Innentasche
- // Verstellbare Träger mit Fix-lock
- // Fischöl- und kältebeständig

DK OVERALL M/ KNÆFORSTÆRKNING

- // Indsvejste knæpuder
- // Inderlomme
- // Justerbare seler med Fix-lock
- // Fiskeolie-resistent og kuldebestandig



MADE IN EUROPE

WATER COLUMN
15.000
MM

Size XS-5XL

Size L inner leg length: 73 cm / 28.5 in
Water column main fabric: > 15.000 mm H₂O



001
OLIVE

100% POLYESTER, COATING: PVC 600 G/M²



Fish oil resistant



Cold resistant



Reinforcement in crotch

ART. 170000

MADE IN EUROPE

WATER COLUMN
15.000
MM

EN **WADERS**

- // Reinforced welding in crotch and legs
- // Short Dunlop boots
- // Inside pocket
- // Adjustable suspenders with Fix-lock
- // Fish oil and cold resistant

D **WATHOSE**

- // Verstärkung im Schritt und Bein
- // Kurze Dunlop Stiefeln
- // Innentasche
- // Fix-lock Schnalle
- // Fischöl- und kältebeständig

DK **WADERS**

- // Forstærket svejsning i skridt og ben
- // Korte Dunlop støvler
- // Inderlomme
- // Fix-lock spænder
- // Fiskeolie-resistent og kuldebestandig



Fish oil resistant



Cold resistant



Reinforcement in crotch



<p>Size 36 - 50</p> <p>Inner leg length at boot size 42: 95 cm / 37.5 in</p> <p>Water column main fabric: > 15.000 mm H₂O</p>
<p>001 OLIVE</p>
<p>100% POLYESTER, COATING: PVC 600 G/M²</p>

AVAILABLE WITH EN ISO 20345 S5 SRA SAFETY BOOTS ART. 170200.



ART. 170000B

MADE IN EUROPE

WATER COLUMN
15.000
MM

EN **WADERS - WIDE MODEL**

- // Reinforced welding in crotch and legs
- // Short Dunlop boots
- // Inside pocket
- // Adjustable suspenders with Fix-lock
- // Fish oil and cold resistant

D **WATHOSE - WEITES MODELL**

- // Verstärkung im Schritt und Bein
- // Kurze Dunlop Stiefeln
- // Innentasche
- // Fix-lock Schnalle
- // Fischöl- und kältebeständig

DK **WADERS - BRED MODEL**

- // Forstærket svejsning i skridt og ben
- // Korte Dunlop støvler
- // Inderlomme
- // Fix-lock spænder
- // Fiskeolie-resistent og kuldebestandig



Fish oil resistant



Cold resistant



Reinforcement in crotch



<p>Size 36 - 50</p> <p>Inner leg length at boot size 42: 96 cm / 38 in</p> <p>Water column main fabric: > 15.000 mm H₂O</p>
<p>001 OLIVE</p>
<p>100% POLYESTER, COATING: PVC 600 G/M²</p>

AVAILABLE WITH EN ISO 20345 S5 SRA SAFETY BOOTS ART. 170200B.



ART. 171700

EN WADERS

- // Reinforced welding in crotch
- // Long Dunlop boots
- // Adjustable suspenders with Fix-lock
- // Fish oil and cold resistant

D WATHOSE

- // Verstärkung im Schritt
- // Lange Dunlop Stiefeln
- // Fix-lock Schnalle
- // Fischöl- und kältebeständig

DK WADERS

- // Forstærket svejsning i skridt
- // Lange Dunlop støvler
- // Seler med Fix-lock
- // Fiskeolie-resistent og kuldebestandig



Fish oil resistant



Cold resistant



Reinforcement in crotch



MADE IN EUROPE

WATER COLUMN
15.000
MM

Size 36 - 50

Inner leg length at boot size 42: 84 cm / 33 in
Water column main fabric: > 15.000 mm H₂O



001
OLIVE

100% POLYESTER, COATING: PVC 600 G/M²



AVAILABLE WITH EN ISO 20345 S5 SRA SAFETY BOOTS ART. 172700.



ART. 171700J

EN WADERS - JUNIOR

- // Reinforced welding in crotch
- // Long Dunlop boots
- // Adjustable suspenders with Fix-lock
- // Fish oil and cold resistant

D WATHOSE - JUNIOR

- // Verstärkung im Schritt
- // Lange Dunlop Stiefeln
- // Fix-lock Schnalle
- // Fischöl- und kältebeständig

DK WADERS - JUNIOR

- // Forstærket svejsning i skridt
- // Lange Dunlop støvler
- // Seler med Fix-lock
- // Fiskeolie-resistent og kuldebestandig



Fish oil resistant



Cold resistant



Reinforcement in crotch



MADE IN EUROPE

WATER COLUMN
15.000
MM

Size 36 - 41

Inner leg length at boot size 39: 81 cm / 32 in
Water column main fabric: > 15.000 mm H₂O



001
OLIVE

100% POLYESTER, COATING: PVC 600 G/M²



ART. 190000

MADE IN EUROPE

WATER COLUMN
20.000
MM

EN HEAVY DUTY WADERS

- // Reinforced welding in crotch and legs
- // Short Dunlop boots
- // Inside pocket
- // Adjustable suspenders with Fix-lock
- // Fish oil and cold resistant

D EXTRA ROBUSTE WATHOSE

- // Verstärkung im Schritt und Bein
- // Kurze Dunlop Stiefeln
- // Innentasche
- // Fix-lock Schnalle
- // Fischöl- und kältebeständig

DK EKSTRA KRAFTIGE WADERS

- // Forstærket svejsning i skridt og ben
- // Korte Dunlop støvler
- // Inderlomme
- // Fix-lock spænder
- // Fiskeolie-resistent og kuldebestandig



<p>Size 36 - 50</p> <p>Inner leg length at boot size 42: 95 cm / 37.5 in</p> <p>Water column main fabric: > 20.000 mm H₂O</p>
<p>001 OLIVE</p>
<p>100% POLYESTER, COATING: PVC 700 G/M²</p>



Fish oil resistant



Cold resistant



Reinforcement in crotch

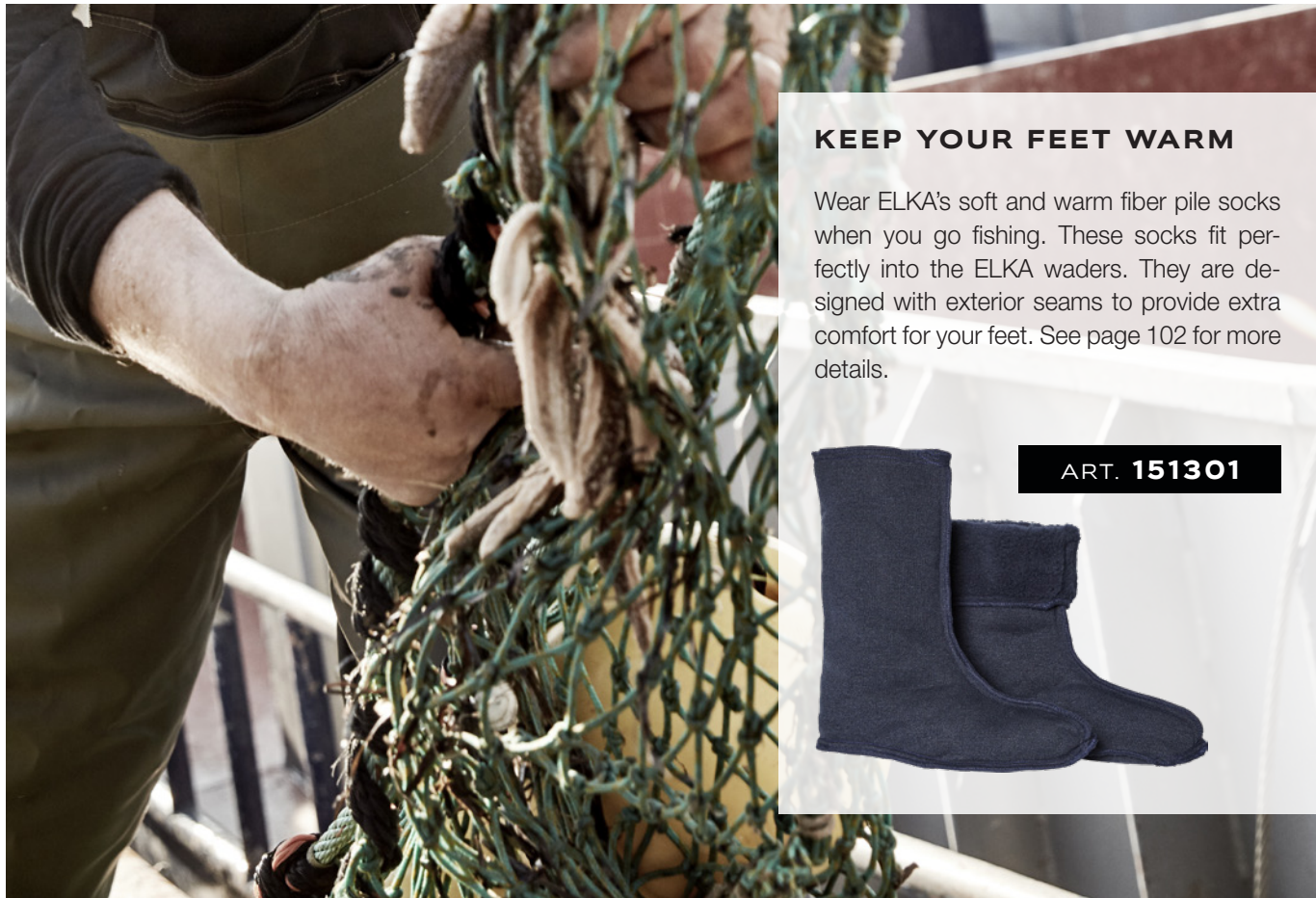

KEEP YOUR FEET WARM

Wear ELKA's soft and warm fiber pile socks when you go fishing. These socks fit perfectly into the ELKA waders. They are designed with exterior seams to provide extra comfort for your feet. See page 102 for more details.



ART. 151301

ART. 031200

EN LEGGINGS

// Fish oil and cold resistant

D HOSENBEINE

// Fischöl- und kältebeständig

DK LØSE BEN

// Fiskeolie-resistent og kuldebestandig



MADE IN EUROPE

WATER COLUMN
15.000
MM

One size

Inner leg length: 66 cm / 26 in
Water column main fabric: > 15.000 mm H₂O



001
OLIVE

100% POLYESTER, COATING: PVC 320 G/M²



Fish oil resistant



Cold resistant

ART. 171900

EN THIGH WADERS

// Long Dunlop boots
// Adjustable suspenders with button fastening
// Fish oil and cold resistant

D WATSTIEFEL

// Lange Dunlop Stiefeln
// Träger mit Knopf-Schnalle
// Fischöl- und kältebeständig

DK SKRIDTSTØVLE

// Lange Dunlop støvler
// Seler med knapspænde
// Fiskeolie-resistent og kuldebestandig



MADE IN EUROPE

WATER COLUMN
15.000
MM

Size 36 - 50

Inner leg length at boot size 42: 90 cm / 35.5 in
Water column main fabric: > 15.000 mm H₂O



001
OLIVE

100% POLYESTER, COATING: PVC 600 G/M²



Fish oil resistant



Cold resistant

AVAILABLE WITH EN ISO 20345 S5 SRA SAFETY BOOTS ART. 172900.



ART. 160528

MADE IN
EUROPE

EN THERMAL JACKET WOMAN

- // High ribbed collar
- // 2 side pockets
- // YKK zipper
- // Ribbed sleeves
- // Longer back

D THERMOJACKE DAME

- // Hoher Kragen mit Rippe
- // 2 Taschen
- // YKK-Reißverschluss
- // Ripp am Ärmel
- // Längeres Rückenteil

DK TERMOJAKKE KVINDE

- // Høj krave med rib
- // 2 lommer
- // YKK-lynlås
- // Rib i ærmer
- // Længere rygstykke



Size XS - 5XL
Size L back length: 70 cm / 27.5 in

010
BLACK

100% POLYESTER 200 G/M²



ART. 160529

MADE IN
EUROPE

EN LONG THERMAL JACKET WOMAN

- // High ribbed collar
- // 2 side pockets with zipper
- // 2-way YKK zipper
- // Ribbed sleeves
- // Longer back

D THERMOJACKE DAME LANG

- // Hoher Kragen mit Rippe
- // 2 Taschen mit Reißverschluss
- // 2-Wege YKK-Reißverschluss
- // Ripp am Ärmel
- // Längeres Rückenteil

DK LANG TERMOJAKKE KVINDE

- // Høj krave med rib
- // 2 lommer med lynlås
- // 2-vejs YKK-lynlås
- // Rib i ærmer
- // Længere rygstykke



Size XS - 5XL
Size L back length: 92 cm / 36 in

010
BLACK

100% POLYESTER 200 G/M²



ART. 161500LADY

EN THERMAL TROUSERS WOMAN

- // Elasticated waist
- // Ribbed legs
- // Check pattern 4x4 cm

D THERMOHOSE DAME



- // Elastik im Bund
- // Ripp am Bein
- // Karo 4x4 cm

DK TERMOBUKSER KVINDE

- // Elastik i talje
- // Rib i ben
- // Tern i 4x4 cm



MADE IN EUROPE

Size XS-5XL Size L inner leg length: 80 cm / 31.5 in
 010 BLACK
100% POLYESTER 200 G/M ²

ART. 168011

EN THERMAL COVERALL WOMAN

- // YKK zipper
- // 2 side pockets
- // Ribbed sleeves and legs
- // High ribbed collar
- // Elasticised waist

D THERMOOVERALL DAME



- // YKK-Reißverschluss
- // 2 Taschen
- // Ripp am Ärmel und am Bein
- // Hoher Kragen mit Rippe
- // Elastik im Bund

DK TERMOHELDRAGT KVINDE

- // YKK-lynlås
- // 2 lommer
- // Rib i ærmer og ben
- // Høj krave med rib
- // Elastik i talje



MADE IN EUROPE

Size XS-5XL Size L inner leg length: 82 cm / 32 in
 001 010 OLIVE BLACK
100% POLYESTER 200 G/M ²

ART. 160500

MADE IN EUROPE

EN THERMAL JACKET

- // Ribbed sleeves and collar
- // YKK zipper
- // Longer back
- // Inside chest pocket
- // Check pattern 4x4 cm

D THERMOJACKE

- // Ripp in Ärmel und am Kragen
- // YKK-Reißverschluss
- // Längeres Rückenteil
- // Brusttasche innen
- // Karo 4x4 cm

DK TERMOJAKKE

- // Rib i ærmer og krave
- // YKK-lynlås
- // Længere rygstykke
- // Indvendig brystlomme
- // Tern i 4x4 cm



Size XS-5XL
Size L back length: 78 cm / 30.5 in



100% POLYESTER 200 G/M²

THE WHITE JACKET CAN BE WASHED AT 95°.

ART. 162500

MADE IN EUROPE

EN THERMAL VEST

- // YKK zipper
- // Inside chest pocket
- // Longer back
- // Check pattern 4x4 cm

D THERMOWESTE

- // YKK-Reißverschluss
- // Brusttasche innen
- // Längeres Rückenteil
- // Karo 4x4 cm

DK TERMOVEST

- // YKK-lynlås
- // Indvendig brystlomme
- // Længere rygstykke
- // Tern i 4x4 cm



Size XS-5XL
Size L back length: 78 cm / 30.5 in

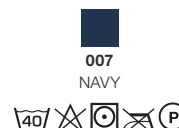

100% POLYESTER 200 G/M²

THE WHITE VEST CAN BE WASHED AT 95°.

ART. 160515

EN THERMAL JACKET

- // YKK zipper
- // 2 pockets
- // Longer back w. button-up flap
- // Ribbed collar
- // Check pattern 4x4 cm

D THERMOJACKE

- // YKK-Reißverschluss
- // 2 Taschen
- // Längeres Rückenteil m. verlängerter Klappe hinten
- // Ripp am Ärmel und am Kragen
- // Karo 4x4 cm

DK TERMOJAKKE

- // YKK-lynlås
- // 2 lommer
- // Længere rygstykke m. klap bagpå
- // Rib i ærmer og krave
- // Tern i 4x4 cm



MADE IN EUROPE

Size XS - 5XL

Size L back length: 70 cm / 27.5 in



001 010
OLIVE BLACK

100% POLYESTER 200 G/M²



ART. 162515

EN THERMAL VEST

- // YKK zipper
- // 2 pockets
- // Longer back w. button-up flap (total length 78 cm)
- // Ribbed collar
- // Check pattern 4x4 cm

D THERMOWESTE

- // YKK-Reißverschluss
- // 2 Taschen
- // Längeres Rückenteil m. verlängerter Klappe hinten (Gesamtlänge 78 cm)
- // Ripp am Kragen
- // Karo 4x4 cm

DK TERMOVEST

- // YKK-lynlås
- // 2 lommer
- // Længere rygstykke m. klap bagpå (total længde 78 cm)
- // Rib i krave
- // Tern i 4x4 cm



MADE IN EUROPE

Size XS-5XL

Size L back length: 70 cm / 27.5 in



001 010
OLIVE BLACK

100% POLYESTER 200 G/M²



ART. 161500

MADE IN EUROPE

EN THERMAL TROUSERS

- // Elasticated waist
- // Ribbed legs
- // Check pattern 4x4 cm

D THERMOHOSE

- // Elastik im Bund
- // Ripp am Bein
- // Karo 4x4 cm

DK TERMOBUKSER

- // Elastik i talje
- // Rib i ben
- // Tern i 4x4 cm



Size XS-5XL
Size L inner leg length: 83 cm / 32.5 in

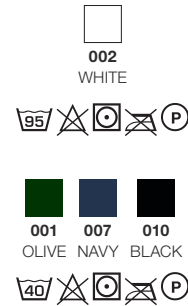

100% POLYESTER 200 G/M²

THE WHITE TROUSERS CAN BE WASHED AT 95°.

ART. 168002

MADE IN EUROPE

EN THERMAL COVERALL

- // YKK zipper
- // 2 side pockets
- // Ribbed legs, sleeves and collar

D THERMOOVERALL

- // YKK-Reißverschluss
- // 2 Taschen
- // Ripp am Bein, Ärmel und am Kragen

DK TERMOHELDRAGT

- // YKK-lynlås
- // 2 lommer
- // Rib i ben, ærmer og krave



Size XS - 5XL
Size L inner leg length: 84 cm / 33 in

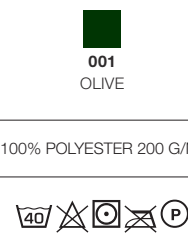

100% POLYESTER 200 G/M²

ART. 160600

EN THERMAL JACKET

- // YKK zipper
- // Inside chest pocket
- // Ribbed sleeves and collar
- // Longer back
- // Check pattern 8x8 cm

D THERMOJACKE



- // YKK-Reißverschluss
- // Brusttasche innen
- // Ripp in Ärmel und am Kragen
- // Längeres Rückenteil
- // Karo 8x8 cm

DK TERMOJAKKE

- // YKK-lynlås
- // Indvendig brystlomme
- // Rib i ærmer og krave
- // Længere rygstykke
- // Tern i 8x8 cm



MADE IN EUROPE

Size XS-5XL Size L back length: 78 cm / 30.5 in
 002 WHITE
100% POLYESTER 280 G/M ²

THE JACKET CAN BE WASHED AT 95°.

ART. 162600

EN THERMAL VEST

- // YKK zipper
- // Inside chest pocket
- // Longer back
- // Check pattern 8x8 cm

D THERMOWESTE



- // YKK-Reißverschluss
- // Brusttasche innen
- // Längeres Rückenteil
- // Karo 8x8 cm

DK TERMOVEST

- // YKK-lynlås
- // Indvendig brystlomme
- // Længere rygstykke
- // Tern i 8x8 cm



MADE IN EUROPE

Size XS-5XL Size L back length: 78 cm / 30.5 in
 002 WHITE
100% POLYESTER 280 G/M ²

THE VEST CAN BE WASHED AT 95°.

ART. 158001

MADE IN
EUROPE

EN FLEECE COVERALL

- // YKK zipper
- // Ribbed sleeves and legs
- // Ribbed collar
- // Elasticised back

D FLEECEOVERALL

- // YKK-Reißverschluss
- // Ripp am Ärmel und am Bein
- // Kragen mit Rippe
- // Elastik im Rücken

DK FLEECE HELDRAGT

- // YKK-lynlås
- // Rib i ærmer og ben
- // Krave med rib
- // Elastik i ryg



Size XS - 5XL
Size L inner leg length: 84 cm / 33 in



007
NAVY

100% POLYESTER FLEECE 280 G/M²



ART. 151301

MADE IN
EUROPE

EN FIBRE PILE SOCKS

- // Soft inside
- // Exterior seams - to make it comfortable for the feet
- // Fits into the Elka waders. The sock fills one size.

D FASERPELZSOCKEN

- // Weiche Innenseite
- // Außennähte - für mehr Komfort für die Füße
- // Passend für die Stiefel der Wathosen. Die Socke macht eine extra Stiefelgröße aus.

DK FIBERPELS SOKKER

- // Blød inderside
- // Udvendige sømme - for at gøre det mere behageligt for fødderne
- // Passer til ELKA Waders stovler. Socken fylder en størrelse.



Size 37/38 - 45/46



007
NAVY

100% POLYESTER 320 G/M²



SUITABLE FOR WADERS. SEE
PAGE 94.

ART. 150400

EN FIBRE PILE JACKET

- // YKK zipper
- // 2 side pockets
- // Ribbed sleeves

D FASERPELZJACKE



- // YKK-Reißverschluss
- // 2 Taschen
- // Ripp am Ärmel

DK FIBERPELS JAKKE

- // YKK-lynlås
- // 2 lommer
- // Rib i ærmer



MADE IN EUROPE

Size XS-5XL Size L back length: 78 cm / 30.5 in
 007 NAVY
100% POLYESTER 320 G/M ²

ART. 151500

EN FIBRE PILE TROUSERS

- // Elasticated waist
- // Ribbed legs

D FASERPELZBUNDHOSE

- // Elastik im Bund
- // Ripp am Bein

DK FIBERPELS BUKSER

- // Elastik i talje
- // Rib i ben



MADE IN EUROPE

Size XS-5XL Size L inner leg length: 83 cm / 32.5 in
 007 NAVY
100% POLYESTER 320 G/M ²





ELEMENTS

BY ELKA

EN

ELKA ELEMENTS is our series for the profile and leisure segments. The products are all made in a stylish Scandinavian design that combines comfort from everyday clothes with professional workwear. The products are made in a modern fit and with a design that can be used both at work and in leisure.

In the **ELKA ELEMENTS** range, it is always possible to find workwear and casual wear that keep you warm and protects against strong winds and persistent rain.

D

ELKA ELEMENTS ist unsere Serie für den Profil- und Freizeitbereich. Die Produkte sind alle in einem skandinavischen Design gefertigt, das den Komfort von Alltagskleidung mit der Praxis professioneller Arbeitskleidung verbindet. Die Produkte sind in moderner Passform und mit einem Design gefertigt, das sowohl im Beruf als auch in der Freizeit verwendet werden kann.

Im Sortiment von **ELKA ELEMENTS** finden Sie immer Arbeits- und Freizeitkleidung, die Sie warm hält und vor starkem Wind und Dauerregen schützt.

DK

ELKA ELEMENTS er vores serie til profil- og fritids-segmenterne. Produkterne er alle fremstillet i et skandinavisk design, der kombinerer komfort fra hverdagstøj med praktikken i professionelt arbejdstøj. Produkterne er lavet i en moderne pasform og med et design, som kan bruges både på arbejde og i fritiden.

I **ELKA ELEMENTS** sortiment er det altid muligt at finde arbejdstøj og fritidstøj, som kan holde dig varm og beskytte dig mod stærk vind og vedvarende regn.

ART. 026200

ELEMENTS
BY ELKA

WATER COLUMN
8.000
MM

EN RECYCLED JACKET

- // 2-way YKK zipper
- // External storm flap with press buttons
- // Internal storm flap
- // Adjustable sleeves

D RECYCELT JACKE

- // 2-Wege YKK-Reißverschluss
- // Externe Wetterschutzleiste mit Druckknöpfen
- // Interne Wetterschutzleiste
- // Ärmel verstellbar

DK RECYCLED JAKKE

- // 2-vejs YKK-lynlås
- // Udvendigt vindfang med trykknapper
- // Indvendigt vindfang
- // Justerbare ærmer



<p>Size XS - 5XL Size L back length: 82 cm / 32 in Water column main fabric: > 8.000 mm H₂O</p>
<p>150 DARK SALAMANDER</p>
<p>100% POLYESTER, COATING: POLYURETHANE 170 G/M²</p>



Recycled
by ELKA



Stretch

ART. 026201

ELEMENTS
BY ELKA

WATER COLUMN
8.000
MM

EN RECYCLED JACKET WOMAN

- // 2-way YKK zipper
- // External storm flap with press buttons
- // Internal storm flap
- // Adjustable sleeves
- // Detachable tie belt at the waist

D RECYCELT JACKE DAME

- // 2-Wege YKK-Reißverschluss
- // Externe Wetterschutzleiste mit Druckknöpfen
- // Interne Wetterschutzleiste
- // Ärmel verstellbar
- // Abnehmbarem Bindegürtel

DK RECYCLED JAKKE KVINDE

- // 2-vejs YKK-lynlås
- // Udvendigt vindfang med trykknapper
- // Indvendigt vindfang
- // Justerbare ærmer
- // Aftageligt bindebælte i taljen



<p>Size XS - 3XL Size L back length: 90 cm / 35.5 in Water column main fabric: > 8.000 mm H₂O</p>
<p>001 150 OLIVE DARK SALAMANDER</p>
<p>100% POLYESTER, COATING: POLYURETHANE 170 G/M²</p>



Recycled
by ELKA



Stretch

ART. 106001

EN **PADDED JACKET**

- // Soft padded jacket w. water-repellent finish
- // Thermal material with high insulation performance
- // 2 side pockets with zippers
- // Sleeves with elastic piping
- // Windbreaker behind zipper

D **STIEPPJACKE**

- // Weiche gepolsterte Jacke m. wasserabweisendes Finish
- // Thermomaterial mit hohe Isolationsleistung
- // 2 Seitentaschen mit Reißverschluss
- // Ärmelabschluss mit Kantenband
- // Schutzleiste hinter dem Frontzipper

DK **VATTERET JAKKE**

- // Blød polstret jakke m. vandafvisende finish
- // Termomateriale med høj isolering
- // 2 sidelommer med lynlås
- // Ærmer med elastik kantbånd
- // Vindfang bag lynlås



ELEMENTS
BY ELKA

Size XS - 5XL Size L back length: 74 cm / 29 in
 010 BLACK
100% POLYAMIDE WITH QUILTING, CONTRAST 100% POLYESTER

ART. 117000

EN **EDGE SOFTSHELL JACKET**

- // Windproof, water repellent and breathable
- // Contrast zippers
- // 3 pockets with zippers
- // Hook & loop adjustment in sleeves
- // Adjustable wrist and lower hem

D **EDGE SOFTSHELLJACKE**



- // Winddicht, wasserabweisend und atmungsaktiv
- // Kontrast Reißverschluss
- // 3 Taschen mit Reißverschluss
- // Klettverschluss am Ärmel
- // Kordelzug an untere Kante

DK **EDGE SOFTSHELL JAKKE**

- // Vindtæt, vandafvisende og åndbar
- // Kontrast lynlås
- // 3 lommer med lynlås
- // Justering i ærmer med gribebånd
- // Snøretræk i nedre kant



ELEMENTS
BY ELKA

Size XS - 5XL Size L back length: 77 cm / 30 in Breathability: > 800 g/m ² /24h
 007 010 NAVY BLACK
100% POLYESTER, 310 G/M ²

ART. 306600

ELEMENTS
BY ELKA

WATER COLUMN
8.000
MM



Size XS - 5XL
Size L back length: 76 cm / 30 in
Water column main fabric: > 8.000 mm H₂O

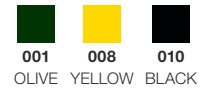

100% POLYESTER, COATING: PU/PVC
320 G/M²



EN JACKET

- // Zipper
- // Storm flap with press buttons
- // Adjustable hood
- // Press buttons in sleeves
- // Reinforced welding on pressure points
- // Air vents in back
- // Pull strings in lower hem
- // Two front pockets with flaps and hook & loop closure

D JACKE

- // Reißverschluss
- // Wetterschutzleiste mit Druckknöpfen
- // Kapuze mit Kordelzug
- // Druckknopf am Ärmel
- // Extra Verschweißung an anfälligen Stellen
- // Rückenentlüftung
- // Kordelzug in der unteren Kante
- // 2 Taschen mit versteckter Klettverschluss

DK JAKKE

- // Lynlås
- // Vindfang med trykknapper
- // Hætte med snoretræk
- // Trykknop i ærmer
- // Forstærkede svejsninger på udsatte steder
- // Rygdulftning
- // Snoretræk i nedre kant
- // 2 lommer med klap og gribebånd

ART. 302400

EN WAIST TROUSERS

- // Press buttons in leg
- // Reinforced welded seams on pressure points
- // Elasticated waist with drawstring

D BUNDHOSE

- // Druckknopf am Bein
- // Extra Verschweißung im Schritt
- // Taillanelastik mit Kordelzug

DK TALJEBUKS

- // Trykknop i ben
- // Forstærket svejsning i skridtet
- // Elastik i talje samt snoretræk



ELEMENTS
BY ELKA

WATER COLUMN
8.000
MM

Size XS - 5XL

Size L inner leg length: 82 cm / 32 in
Water column main fabric: > 8.000 mm H₂O

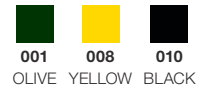

100% POLYESTER, COATING: PU/PVC
320 G/M²



ART. 309900

EN BIB & BRACE

- // Press buttons in leg
- // Press buttons in chestpiece
- // Adjustable suspenders with Fix-lock
- // Reinforced welded seams on pressure points

D LATZHOSE

- // Druckknopf am Bein
- // Druckknopf im Seitenteil
- // Verstellbare Träger mit Fix-lock
- // Extra Verschweißung im Schritt

DK OVERALL

- // Trykknop i ben
- // Trykknop i sidestykke
- // Justerbare seler med Fix-lock spænde
- // Forstærket svejsning i skridtet



ELEMENTS
BY ELKA

WATER COLUMN
8.000
MM

Size XS - 5XL

Size L inner leg length: 72 cm / 28.5 in
Water column main fabric: > 8.000 mm H₂O

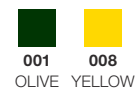

100% POLYESTER, COATING: PU/PVC
320 G/M²



ART. 104500

EN THERMAL BASE LAYER - CREW SHIRT

- // Cooldry® - insulating and breathable base layer fabric
- // Light weight and quick drying
- // 20% stretch
- // Long Raglan sleeves with cuffs
- // Contrast flatlock seams

D THERMO FUNKTIONS UNTERHEMD

- // Cooldry® isolierendes und atmungsaktiv Grundgewebe
- // Leichtgewicht und schnelltrockend
- // 20% Stretch
- // Lange Raglanärmel mit Manschetten
- // Kontrast Flatlock-Nähte

DK TERMO BASE LAYER - UNDERTRØJE

- // Cooldry® - isolerende og åndbar metervare
- // Letvægt og hurtigtørrende
- // 20% stretch
- // Lange Raglanærmer med manchetter
- // Flat-lock kontrastsømme



ELEMENTS
BY ELKA

<p>Size XS-5XL Size L back length: 74 cm / 29 in</p>
<p>010 BLACK</p>
<p>100% POLYESTER COOLDRY® 180 G/M²</p>
<p>40/ [Washing symbols: 40°C, no bleach, no iron, no dry clean, no tumble dry]</p>

ART. 102900

EN THERMAL BASE LAYER UNDER TROUSERS

- // Cooldry® insulating and breathable base layer fabric
- // Light weight and quick drying
- // 20% stretch
- // Elastic in waist
- // Contrast flatlock seams

D THERMO FUNKTIONS UNTERHOSE

- // Cooldry® isolierendes und atmungsaktiv Grundgewebe
- // Leichtgewicht und schnelltrockend
- // 20% Stretch
- // Elastik im Bund
- // Kontrast Flatlock-Nähte

DK TERMO BASE LAYER UNDERBUKSER

- // Cooldry® isolerende og åndbar metervare
- // Letvægt og hurtigtørrende
- // 20% stretch
- // Elastik i talje
- // Flat-lock kontrast sømme



ELEMENTS
BY ELKA

<p>Size XS-5XL Size L inner leg length: 81 cm / 32 in</p>
<p>010 BLACK</p>
<p>100% POLYESTER COOLDRY® 180 G/M²</p>
<p>40/ [Washing symbols: 40°C, no bleach, no iron, no dry clean, no tumble dry]</p>



ART. 035005
100% POLYESTER,
COATING: PVC 320 G/M²

PVC CAP
// Adjustable
// Ventilation

010
BLACK



ART. 098501
POLYETHYLEN

RAIN PONCHO
// Foil
// Length 102 cm
// Width 125 cm

081
TRANS-
PARENT



ART. 035001
100% POLYESTER,
COATING: PVC 320 G/M²

RAIN HAT
// Rain Hat

001 007 008
OLIVE NAVY YELLOW



ART. 136002
50% MERINO WOOL /
50% ACRYLIC W. BRUSHED
BACKING

**KNITTED
BEANIE/ HAT**
// Warm wool mix
beanie
// Fleece material inside
// Elastic material, fits all
head shapes

010
BLACK



ART. 3250
NEOPRENE

**NEOPRENE
KNEE PADS**
// Neoprene
// Width: 19 cm
// Length: 34 cm
// Thickness: 0,3 cm

010
BLACK



ART. 3260
FOAM

**FOAM KNEE
PADS**
// Foam Knee Pads
// Width: 15,5 cm
// Length: 27 cm
// Thickness: 1,2 cm
// Adjustable in length
and width

012
GREY

USEFUL INDEX

0163124.....	65	072400.....	76	086104.....	44	150015R.....	17, 115	182400.....	36
018001.....	84	072400R.....	82	086150R.....	58	150016.....	39	182400R.....	16
022400.....	64	075810.....	81	086151R.....	56, 115	150400.....	103	182401.....	36
022400R.....	70	076300.....	76	086500R.....	23	151301.....	94, 102	182401R.....	16
022401.....	69	076300R.....	82	088000R.....	25	151500.....	103	182403.....	5, 29
022401R.....	71	077100.....	77	088002.....	45	156060.....	55, 115	182403R.....	5, 11
022402.....	68	077100E.....	77	088002W.....	45	158001.....	102	186000.....	35, 115
022403R.....	72	078000.....	78	088004.....	46	160014.....	38, 115	186000R.....	15, 115
022450.....	59	078000R.....	84	088004W.....	47	160500.....	98	186003.....	5, 28
022450R.....	61	078800R.....	83	089000R.....	21	160515.....	99	186003R.....	5, 10
022451R.....	61	079000.....	85	089902.....	41	160528.....	96	186100.....	34
026200.....	106	079800E.....	78	089951R.....	57	160529.....	96	186100R.....	14
026201.....	106	079800R.....	83	092200.....	85	160600.....	101	186101.....	37
026300.....	64	079900.....	79	097600.....	87	161500.....	100	190000.....	94
026300R.....	70	079900E.....	79	098501.....	111	161500LADY.....	97	282404.....	5, 32, 33
026301.....	69	079902.....	80	102900.....	110	162500.....	98	282404R.....	5, 13
026301R.....	71	079904.....	80	104500.....	110	162515.....	99	282404S.....	5, 32, 33
026302.....	68	082400R.....	19	106001.....	107	162600.....	101	282404SR.....	5, 13
026350.....	59	082402.....	41	106003.....	5, 31	166060.....	55, 115	302400.....	67, 109
026350R.....	60	082403.....	42	116500.....	48	166151.....	57, 115	306600.....	66, 108
028003.....	66	082405.....	43	116503.....	5, 30	168002.....	100	309900.....	67, 109
028003R.....	73	082405R.....	20	116503R.....	5, 12	168011.....	97	3250.....	111
028100R.....	73	082450R.....	58	116504R.....	23	170000.....	92	3260.....	111
028800R.....	72	082460R.....	53	116505R.....	22	170000B.....	92	3320.....	81
028850R.....	60	086002.....	40	116514R.....	24	171700.....	93		
029900.....	65	086003.....	42	117000.....	107	171700J.....	93		
031200.....	95	086004.....	44, 115	117200.....	49	171900.....	95		
032400.....	88	086004R.....	21, 115	117300.....	49	175809.....	81		
033800.....	86	086005.....	43	117300R.....	22	177101.....	89		
035001.....	111	086005R.....	20	117301.....	48	177301.....	91		
035005.....	111	086060.....	54, 115	132201R.....	25	177303.....	91		
035700.....	81	086060R.....	52, 115	136002.....	111	179801.....	90		
036600.....	86	086100R.....	19	150014.....	39, 115	179806.....	90		
037100.....	87	086101R.....	24	150014R.....	17, 115	179806C.....	90		
039900.....	88	086103.....	40	150015.....	38, 115	179909.....	89		

CERTIFICATIONS

THE ELKA RAINWEAR PRODUCTION COMPLIES WITH
THE COMMON EUROPEAN **CE REGULATIONS**. ALSO KNOWN AS **EN MARKINGS**

EN



PROTECTIVE CLOTHING: PROTECTION AGAINST RAIN

Standards for test method and requirements for fabric, seams and functionality. Applies to both waterproofability and breathability.

D

SCHUTZKLEIDUNG GEGEN REGEN

Norm für Testverfahren und Anforderungen an Meterwaren, Nähte und Funktion. Regelt Wasser-dichtigkeit und Atmungsaktivität gleichermaßen.

DK

BESKYTTELSESBEKLÆDNING MOD REGN

Standard for testmetode og krav til metervarer, sømme og funktion. Angår såvel vandtæthed som åndbarhed.

EN ISO 20471



PROTECTIVE CLOTHING: HIGH VISIBILITY CLOTHING

Standards for the requirements for garments that ensure the visibility of the wearer. Both the fluorescent material and the reflective tape have to be used for approved visibility.

SCHUTZKLEIDUNG – DEUTLICH SICHTBARE WARNBEKLEIDUNG FÜR DEN PROFESSIONELLEN GEBRAUCH

Norm für Anforderungen an Kleidung zwecks erhöhter Wahrnehmbarkeit des Benutzers. Die Zulassung als wahrnehmbare Kleidung setzt die Kombination von fluoreszierendem Material mit retroreflektierenden Streifen voraus.

BESKYTTELSESBEKLÆDNING – TYDELIG SYNLIG ADVARSELSE- BEKLÆDNING TIL PROFESSIONEL BRUG

Standard for kravene til beklædning som sikrer brugerens synlighed. Både det fluorescerende materiale og refleksstriberne skal benyttes for godkendt synlighed.

RIS-3279-TOM



RIS-3279-TOM

Whereas the European standard permits several different colors of high-visibility materials, the GB railway standard specifies an orange color.

RIS-3279-TOM

RIS-3279-TOM zertifizierte Bekleidung wird bei der Englischen Eisenbahngesellschaften verlangt.

RIS-3279-TOM

RIS-3279-TOM certificeret beklædning bruges på de engelske jernbaner.

EN 342



PROTECTIVE CLOTHING – GARMENTS FOR PROTECTION AGAINST COOL ENVIRONMENTS

This standard specifies requirements and test methods for the performance of garments for protection against the effects of cool environments equal to or below -5°C. These effects comprise not only low air temperatures, but also humidity and air velocity.

SCHUTZKLEIDUNG – KLEIDUNGSSTÜCKE ZUM SCHUTZ GEGEN KÜHLE UMGEBUNGEN

Diese Norm legt Anforderungen und Prüfverfahren für die Leistung von Kleidungsstücken zum Schutz gegen die Auswirkungen einer kühlen Umgebung von -5°C oder weniger fest. Diese Effekte umfassen nicht nur niedrige Lufttemperaturen, sondern auch Luftfeuchtigkeit und Luftgeschwindigkeit.

BESKYTTELSESBEKLÆDNING – TIL BESKYTTELSE MOD KOLDE OMGIVELSER

Denne standard beskriver krav og testmetoder til ydeevne af beklædningsgenstande, der beskytter mod virkningerne af et køligt miljø lig med eller under -5°C. Disse effekter omfatter ikke kun lave luft-temperaturer, men også fugtighed og vind.

EN 14058



PROTECTIVE CLOTHING – GARMENTS FOR PROTECTION AGAINST COOL ENVIRONMENTS

This standard specifies requirements and test methods for the performance of garments for protection against the effects of cool environments above -5°C. These effects comprise not only low air temperatures, but also humidity and air velocity.

SCHUTZKLEIDUNG – KLEIDUNGSSTÜCKE ZUM SCHUTZ GEGEN KÜHLE UMGEBUNGEN

Diese Norm legt Anforderungen und Prüfverfahren für die Leistung von Kleidungsstücken zum Schutz gegen die Auswirkungen einer kühlen Umgebung über -5°C fest. Diese Effekte umfassen nicht nur niedrige Lufttemperaturen, sondern auch Luftfeuchtigkeit und Luftgeschwindigkeit.

BESKYTTELSESBEKLÆDNING – TIL BESKYTTELSE MOD KOLDE OMGIVELSER

Denne standard beskriver krav og testmetoder til ydeevne af beklædningsgenstande, der beskytter mod virkningerne af et køligt miljø over -5°C. Disse effekter omfatter ikke kun lave luft-temperaturer, men også fugtighed og vind.

EN 1186



GLASS AND FORK

This product, which is labeled "Glass & Fork", can be used as waterproof garment in the context of worker tasks in the food processing industry, e.g. cleaning, slaughtering and packing.

GLAS UND GABEL

Das Produkt, welches mit dem "Glas-Gabel Symbol" gekennzeichnet ist, kann als Wasserdichte Bekleidung in Verbindung mit Arbeitsaufgaben wie Reinigung, Schlachten und Verpackung in der Lebensmittelindustrie eingesetzt werden.

GLAS & GAFFEL

Produkter mærket med "Glas & Gaffel" kan bruges som vandtæt beklædning i forbindelse med arbejdsopgaver i fødevarerindustrien, som f.eks. rengøring, slagtning og pakning.

EN 13034



PROTECTIVE CLOTHING AGAINST LIQUID CHEMICALS

This standard specifies the minimum requirements to be met by protective clothing against chemicals offering limited protective effect, including reusable protective clothing. Protective clothing against chemicals offering limited protective effect is for use where there is a possibility of exposure to minor chemical spraying, liquid aerosols or low-pressure spattering.

SCHUTZBEKLEIDUNG GEGEN FLÜSSIGE CHEMIKALIEN

Diese Norm legt Mindestanforderungen an Chemikalienschutzbekleidung mit eingeschränkter Schutzwirkung einschließlich wiederverwendbarer Schutzbekleidung fest. Chemikalienschutzbekleidung mit eingeschränkter Schutzwirkung ist für die Verwendung in Fällen einer möglichen Exposition gegenüber leichter Chemikalienvernebelung, flüssigen Aerosolen oder mit niedrigem Druck auftreffenden Spritzern geeignet.

BESKYTTELSESBEKLÆDNING MOD FLYDENDE KEMIKALIER

Normen beskriver ydeevnekrav til kemikaliebeskyttelsesbeklædning, som yder en begrænset beskyttelse mod flydende kemikalier (type 6- og type PB [6]-udstyr). Kemikaliebeskyttelsesbeklædning med begrænset ydeevne er beregnet til brug i tilfælde af en potentiel eksponering mod lette sprøjt, væskeforstøvning eller sprøjt med lavt tryk og mængde.

CERTIFICATIONS

THE ELKA RAINWEAR PRODUCTION COMPLIES WITH
THE COMMON EUROPEAN CE REGULATIONS, ALSO KNOWN AS EN MARKINGS

EN

EN 14605



PROTECTIVE CLOTHING AGAINST LIQUID CHEMICALS

Performance requirements for clothing with liquid-tight (type 3) or spraytight (type 4) connections, including items providing protection to parts of the body only (types PB (3) and PB (4)).

D

SCHUTZKLEIDUNG GEGEN FLÜSSIGE CHEMIKALIEN

Leistungsanforderungen an Anzüge mit flüssigkeitsdichten (Typ 3) oder spraydichten (Typ 4) Nähten, inkl. solcher Kleidungsstücke, die nur Teile des Körpers Schutz bieten (Typ PB (3) bzw. PB (4)).

DK

BESKYTTELSSEBEKLÆDNING MOD FLYDENDE KEMIKALIER

Ydelseskrav til dragter med væsketætte (type 3) eller spraytætte (type 4) samlinger, inklusive beklædningsstykker, som kun giver beskyttelse til dele af kroppen (type PB (3) og PB (4)).

EN 14126



PROTECTIVE CLOTHING AGAINST INFECTIVE AGENTS

This standard specifies requirements and test methods for re-usable and limited use protective clothing providing protection against infective agents.

SCHUTZKLEIDUNG GEGEN INFEKTIONSERREGER

Diese Norm legt Anforderungen und Prüfverfahren für wiederverwendbare und begrenzt verwendbare Schutzkleidung zum Schutz vor Infektionserregern fest.

BESKYTTELSSEBEKLÆDNING MOD SMITSOMME AGENTER

Denne standard beskriver krav og testmetoder for beskyttelsesbeklædning, der giver beskyttelse mod smitsomme agenter. Genanvendelig beklædning med begrænset brugstid.

EN ISO 11611



PROTECTIVE CLOTHING FOR USE IN WELDING AND RELATED PROCESSES

This type of protective clothing is intended to protect the wearer against weld spatter (small splashes of molten metal), short-term contact with flames as well as radiant heat from the electric arc. Under normal welding conditions, it offers limited electrical insulation against electric conductors of up to 100 V DC. This standard sets out two classes with specific performance requirements (class 1 is for lower requirements, class 2 for higher requirements).

SCHUTZKLEIDUNG FÜR SCHWEISSEN UND VERWANDTE VERFAHREN

Diese Schutzbekleidung schützt den Träger gegen Schweißspritzer (kleine Spritzer geschmolzenen Metalls), kurzzeitigen Kontakt mit Flammen sowie Strahlungswärme aus einem elektrischen Lichtbogen. Sie bietet unter üblichen Schweißbedingungen in begrenztem Maße elektrische Isolation gegenüber unter Gleichspannung stehenden, elektrischen Leitern, bis ca. 100 V. Diese Norm wird in zwei Klassen mit spezifischen Leistungsanforderungen festgelegt (wobei Klasse 1 die niedrigere und Klasse 2 die höhere Anforderung beschreibt).

BESKYTTELSSEBEKLÆDNING – BEKLÆDNING TIL BESKYTTELSE VED SVEJSNING

Standarden angiver minimumskravet til beskyttelsesbeklædning, der beskytter brugeren ved kortvarig svejsning og processer med lignende risici. EN ISO 11611 certificeret beskyttelsesbeklædning skal beskytte brugeren mod kortvarig kontakt med ild og kort, tilfældig kontakt med elektroniske ledere. Normen er inddelt i to klasser, der angiver beskyttelsesniveauet for tøjet. Sikkerhedsbeklædning i klasse 1 er til beskyttelse mod situationer, hvor der er en mindre risiko for udledning af gnister og strålevarme. Klasse 2 er til beskyttelse i mere risikable situationer, og hvor risikoen for strålevarme er tydeligt større.

EN 1149-5



PROTECTIVE CLOTHING – ELECTROSTATIC PROPERTIES

Part 5: Requirements for the material's performance and design

ARBEITS-SCHUTZKLEIDUNG – ELEKTROSTATISCHE EIGENSCHAFTEN

TEIL 5: Anforderungen zu den Leistungen und Design des Materials.

BESKYTTELSSEBEKLÆDNING – ELEKTROSTATISKE EGENSKABER

Del 5: Krav til materialets ydeevne og design.

EN ISO 14116



PROTECTIVE CLOTHING – PROTECTION AGAINST FLAMES

Limited flame spread materials, material assemblies and clothing.

ARBEITS-SCHUTZKLEIDUNG – SCHUTZ GEGEN FLAMMEN

Materialien, Materialkombinationen und Bekleidung mit begrenzter Flammverbreitung

BESKYTTELSSEBEKLÆDNING – BESKYTTELSE MOD FLAMMER

Materialer, materialekombinationer og beklædning med begrænset flammespredning.

EN ISO 11612



CLOTHING TO PROTECT AGAINST HEAT AND FLAME

This international standard specifies the minimum requirements for clothing protecting against heat and/or flames. In a wide variety of fields of application, the wearer can also be exposed to convective, radiant or contact heat, as well as splashes of molten metal. Within the standard, letters A-F define the performance levels relating to the protective properties listed above.

SCHUTZKLEIDUNG – BEKLÆDNING ZUM SCHUTZ GEGEN HITZE UND FLAMMEN

Diese internationale Norm legt Mindestanforderungen für Bekleidung zum Schutz vor Hitze und / oder Flammen fest. In einem breit gefächerten Einsatzbereich kann der Träger auch konvektiver Wärme, Strahlungs- oder Kontaktwärme sowie Spritzern geschmolzenen Metalls ausgesetzt sein. Innerhalb der Norm definieren die Buchstaben A-F die Leistungsstufen in Bezug auf oben genannte Schutzigenschaften.

BESKYTTELSSEBEKLÆDNING – BEKLÆDNING TIL BESKYTTELSE MOD VARME OG ILD

Denne internationale standard specificerer minimumskravene til tøj, der beskytter mod varme og / eller flammer. I en bred vifte af anvendelsesområder kan bæreren også udsættes for konvektiv, strålende eller kontaktvarme samt stænk af smeltet metal. Inden for standarden definerer bogstaverne A-F præstationsniveauerne for de ovenfor beskrevne beskyttende egenskaber.

IEC 61482-2



PROTECTIVE CLOTHING AGAINST THE THERMAL HAZARDS OF AN ELECTRIC ARC

This type of protective clothing is intended to protect the wearer against thermal effects of a defined electric fault arc and prevents continued burning. The clothing protects the wearer against a certain type of heat in connection with an electric arc. The heat can be convective and radiating, caused by splashes of molten metal, or also a combination of the two aforementioned hazards.

SCHUTZBEKLÆDUNG GEGEN DIE THERMISCHEN GEFAHREN EINES ELEKTRISCHEN LICHTBOGENS

Diese Schutzbekleidung schützt den Träger gegen die thermischen Auswirkungen eines elektrischen Störlichtbogens entsprechend dem geprüften Schutzniveau bzw. der Schutzklasse. Neben grundlegenden Anforderungen wird die Prüfung mit einem elektrischen Störlichtbogen gefordert.

BESKYTTELSSEBEKLÆDNING MOD TERMISK FARE FRA EN ELEKTRISK LYSBUE

Denne standard for beskyttelsesbeklædning, er beregnet til at beskytte brugeren mod termiske virkninger af en defineret elektrisk fejlbue og forhindrer fortsat brænding. Tøjet beskytter brugeren mod en bestemt type varme i forbindelse med en lysbue. Varmen kan være konvektiv og stråling forårsaget af stænk af smeltet metal eller en kombination af de to ovennævnte farer.

HOW TO MEASURE

ELKA RAINWEAR SIZES

We recommend you get the help of another person when taking measurements. Measurements should be taken directly on the body, preferably while wearing a tight-fitting garment and without pressing into the skin. All measurements in the size chart are provided in both cm and inches. If your measurement falls between two sizes, we advise you to choose the larger size.

CHEST:

Measure around chest at the widest point with arms at against side.

WAIST:

Measure around the narrowest part of the waistline.

HIPS:

Measure around the hips at the widest point.

HEIGHT:

Measure from feet to top of the head.

INNER LEG LENGTH:

Measure from the crotch down to your ankle bone.

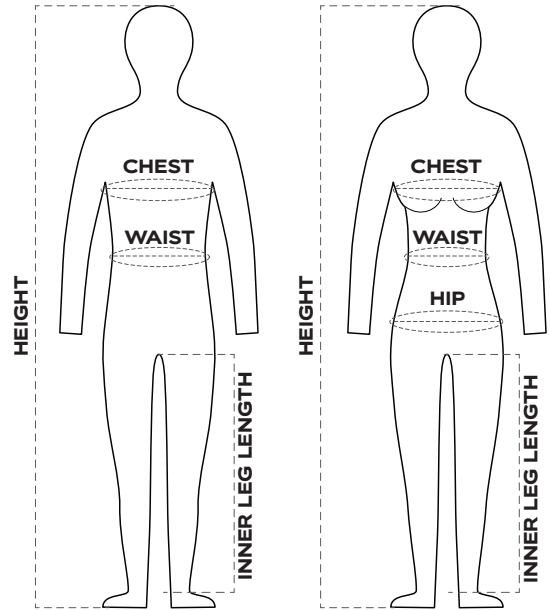

MEASUREMENT CHART ELKA MEN - UNISEX:

	XS	S	M	L	XL	2XL	3XL	4XL	5XL
Chest (cm)	84-88	92-96	100-104	108-112	116-120	124-128	132-136	140-144	148-152
Chest (inch)	33-34.5	36-37.5	39.5-41	42.5-44	45.5-47	49-50.5	52-53.5	55-56.5	58-60
Waist (cm)	70-74	78-82	86-90	94-98	102-106	110-114	118-122	126-130	134-138
Waist (inch)	27.5-29	30.5-32	33.5-35.5	37-38.5	40-42	43-45	46.5-48	49.5-51	53-54.5

Height 170-190 cm / 67-75 inch.

MEASUREMENT CHART ELKA MEN - WORKPANTS:

Normal length sizes

EU	44	46	48	50	52	54	56	58	60
UK/US	28.5	30.5	32.5	34.5	36.5	38.5	40.5	42.5	44.5
CH/F	38	40	42	44	46	48	50	52	54
Waist (cm)	74-78	79-82	83-86	87-90	91-95	96-100	101-105	106-111	112-117
Waist (inch)	29-30.5	31-32	32.5-33.5	34-35.5	36-37.5	38-39.5	40-41.5	42-43.5	44-46

EU	62	64	66	68
UK/US	46.5	48.5	50.5	52.5
CH/F	56	58	60	62
Waist (cm)	118-123	124-129	130-134	135-138
Waist (inch)	46.5-48.5	49-50.5	51-53	53-54.5

Short length sizes

EU	23	24	25	26	27	28	29	30	31
UK/US	30.5	32.5	34.5	36.5	38.5	40.5	42.5	44.5	46.5
CH/F	40	42	44	46	48	50	52	54	56
Waist (cm)	79-82	83-86	87-90	91-95	96-100	101-105	106-111	112-117	118-123
Waist (inch)	31-32	32.5-33.5	34-35.5	36-37.5	38-39.5	40-41.5	42-43.5	44-46	46.5-48.5

Height 170-190 cm / 67-75 inch.

MEASUREMENT CHART ELKA WOMEN:

	XS	S	M	L	XL	2XL	3XL	4XL	5XL
Chest (cm)	78-82	84-88	92-96	100-104	108-112	116-120	124-128	132-136	140-144
Chest (inch)	30.5-32	33-34.5	36-37.5	39-41	42.5-44	45.5-47	49-50.5	52-53.5	55-56.5
Waist (cm)	64-68	72-76	80-84	88-92	96-100	104-108	112-116	120-124	128-132
Waist (inch)	25-26.5	28.5-30	31.5-33	34.5-36	38-39.5	41-42.5	44-45.5	47.5-49	49-52
Hips (cm)	86-90	92-96	100-104	108-112	116-120	124-128	132-136	140-144	148-152
Hips (inch)	33.5-35.5	36-37.5	39.5-41	42.5-44	45.5-47	49-50.5	52-53.5	55-56.5	58-60

Height 160-180 cm / 63-70.5 inch.

ELKA ZIP-IN OPTIONS

ART. 18600R



VISIBLE XTREME STRETCH JACKET

ART. 086004R



VISIBLE XTREME JACKET

ART. 186000



WORKING XTREME STRETCH JACKET

ART. 086004



WORKING XTREME JACKET



ART. 150015R



VISIBLE XTREME MIDLAYER ZIP-IN JACKET

ART. 150014R



VISIBLE XTREME ZIP-IN FLEECE

ART. 150014



WORKING XTREME FLEECE ZIP-IN JACKET

ART. 150015



WORKING XTREME MIDLAYER ZIP-IN JACKET

ART. 160014



WORKING XTREME THERMAL ZIP-IN JACKET

ART. 086060



SECURETECH MULTINORM ELECTRIC ARC JACKET

ART. 086060R



SECURETECH MULTINORM ELECTRIC ARC JACKET

ART. 086151R



SECURETECH MULTINORM SHELL JACKET



ART. 156060



SECURETECH MULTINORM ANTIFLAME ZIP-IN FLEECE JACKET

ART. 166060



SECURETECH MULTINORM ANTIFLAME ZIP-IN JACKET

ART. 166151



SECURETECH MULTINORM ANTIFLAME ZIP-IN JACKET

ELKA ZIP-IN OPTIONS

Get full flexibility with zip-in. Choose a wind-proof, waterproof and breathable Visible Xtreme, Working Xtreme or SecureTech Multinorm shell jacket as the outer layer and place an insulating thermal or fleece jacket into the shell jacket – this gives you the possibility to easily adjust your workwear for the changing temperatures during the day.

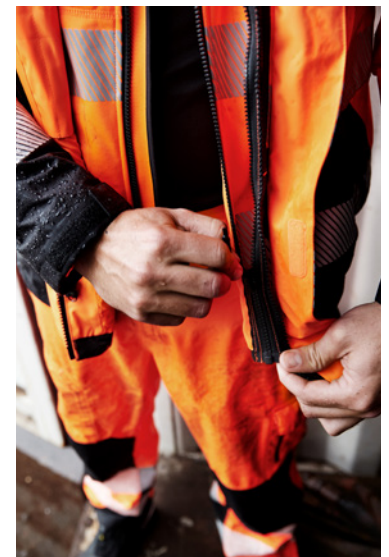



ELKA
SINCE 1958

ELKARAINWEAR.DK

ELKA RAINWEAR A/S
NAVERVEJ 22-24, 7451 SUNDS, DENMARK, TEL. +45 97 14 24 22
ELKA@ELKARAINWEAR.DK

